

Nanofabrication with 3D DNA Origami

 DANA-FARBER
CANCER INSTITUTE

WYSS  INSTITUTE

 HARVARD MEDICAL
SCHOOL

William Shih

Thursday, 2009 August 20

 DANA-FARBER
CANCER INSTITUTE

WYSS  INSTITUTE

 HARVARD MEDICAL
SCHOOL



flea
1 mm



protozoan
0.1 mm

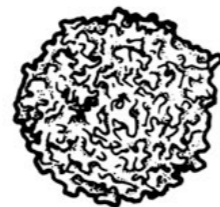

white blood
cell
0.01 mm



E. coli
1 μm

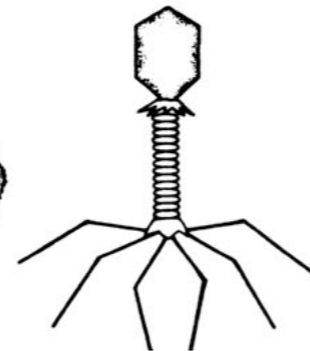

T2 phage
0.1 μm

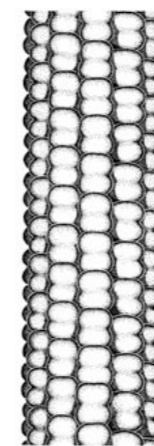

microtubule
25 nm



DNA
2 nm



atoms in
DNA
0.2 nm

Shawn Douglas

Wyss Technology Development Fellow

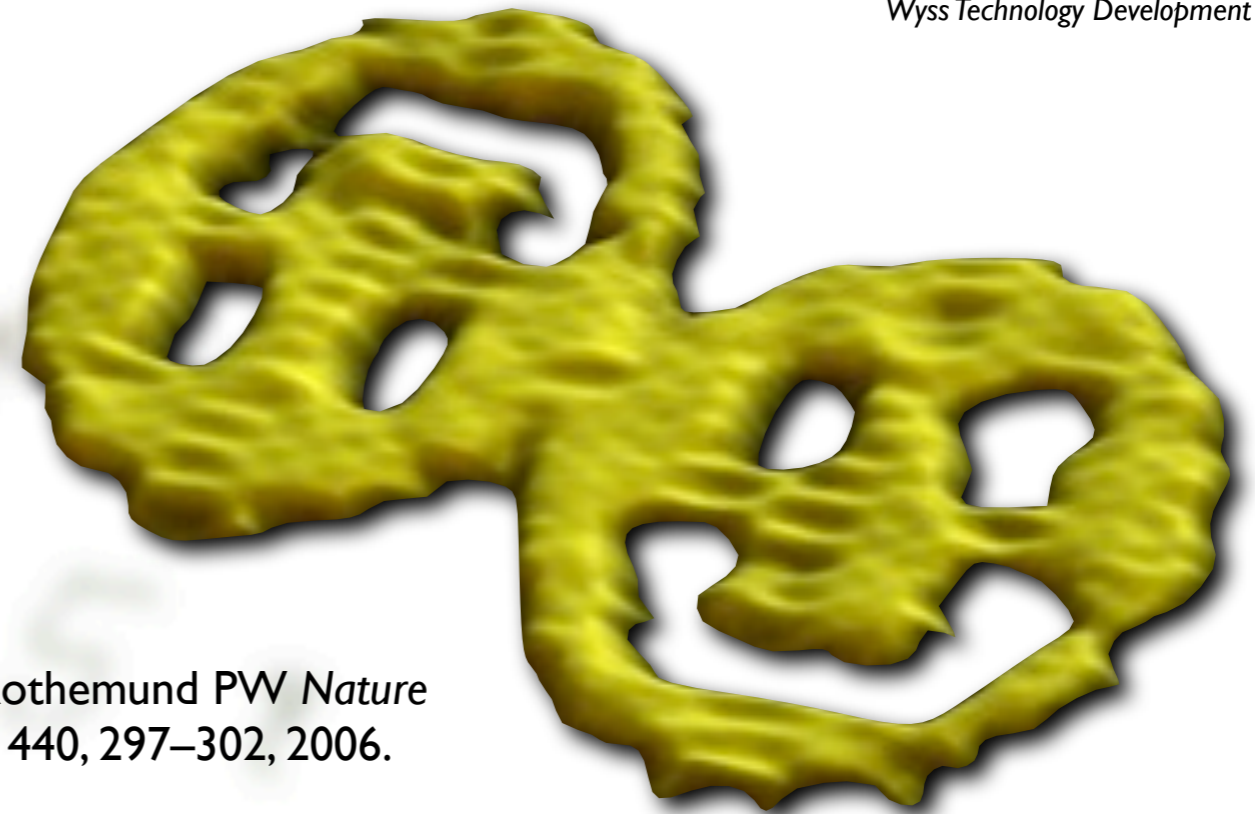

Rothemund PW *Nature*
440, 297–302, 2006.



100 nm

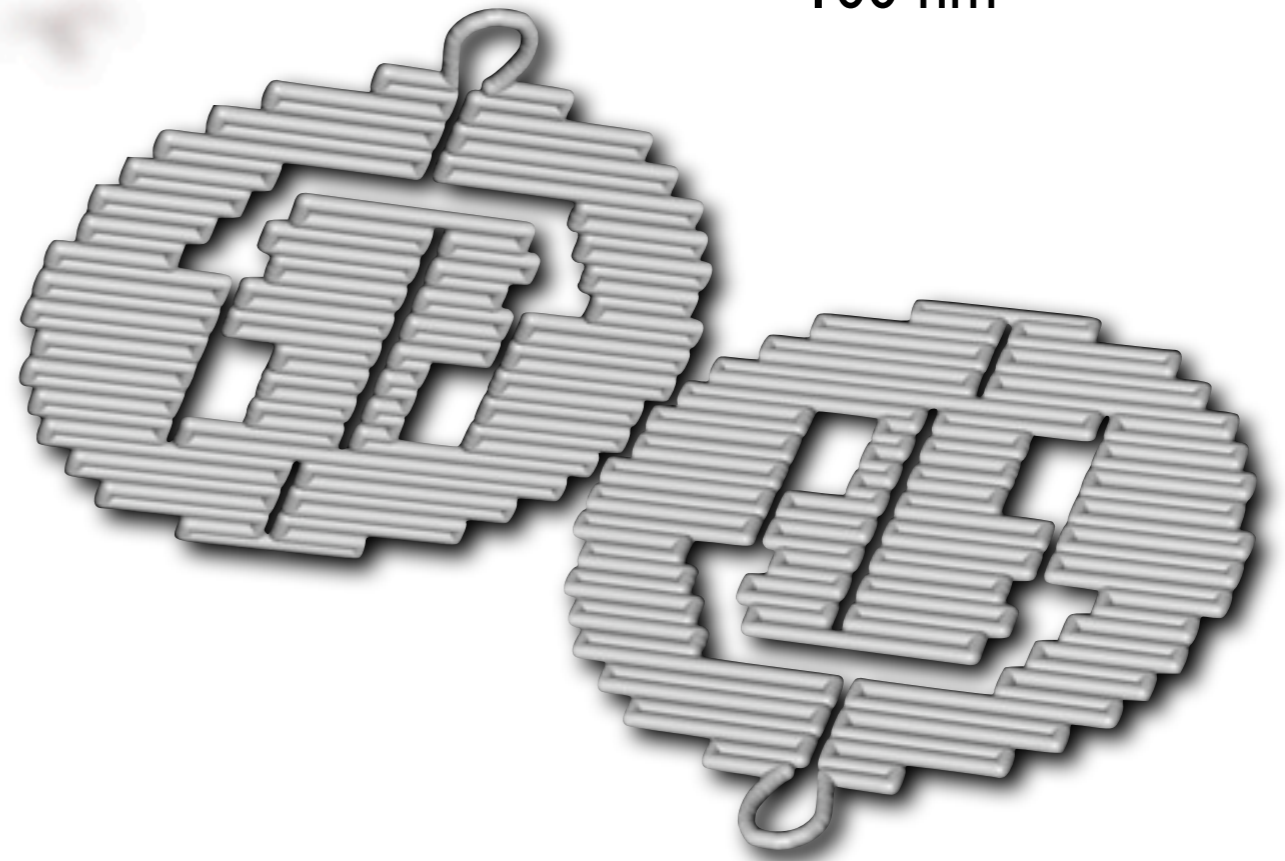

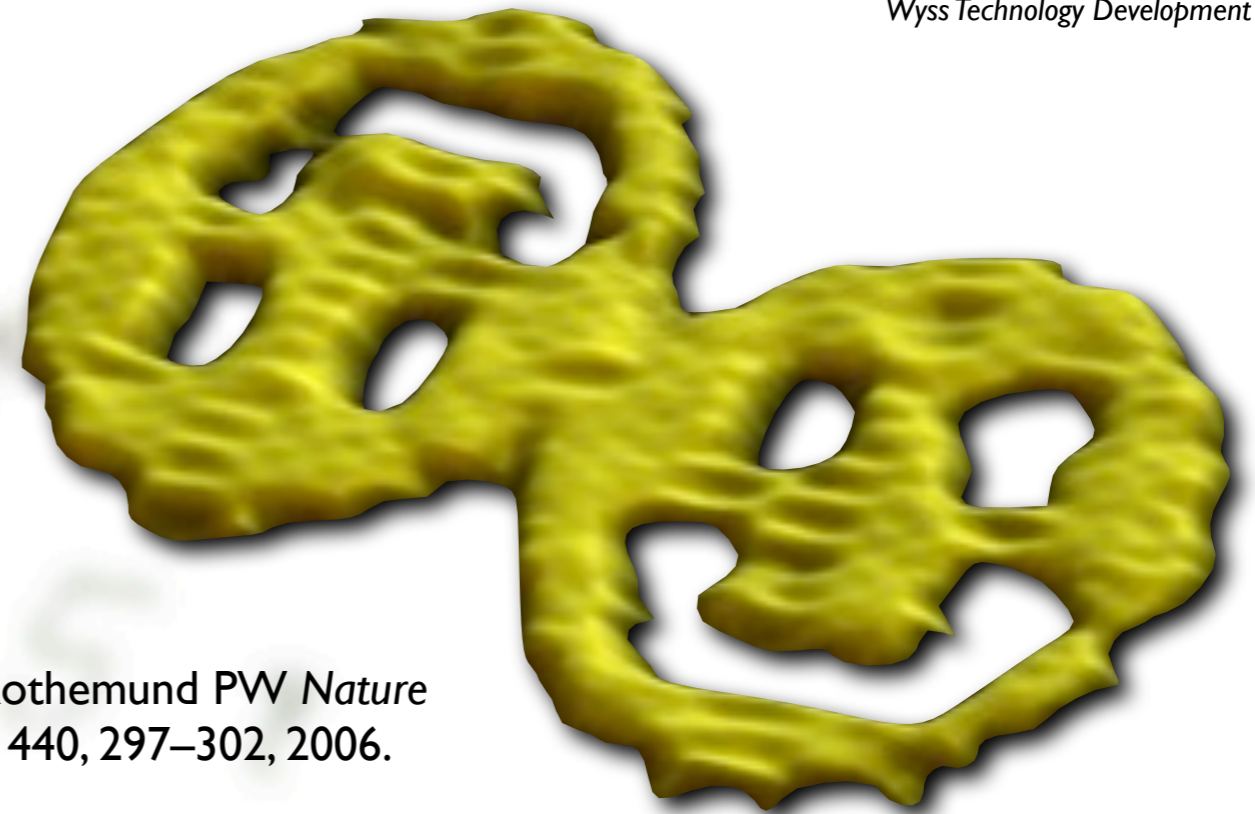

Rothmund PW *Nature*
440, 297–302, 2006.



100 nm

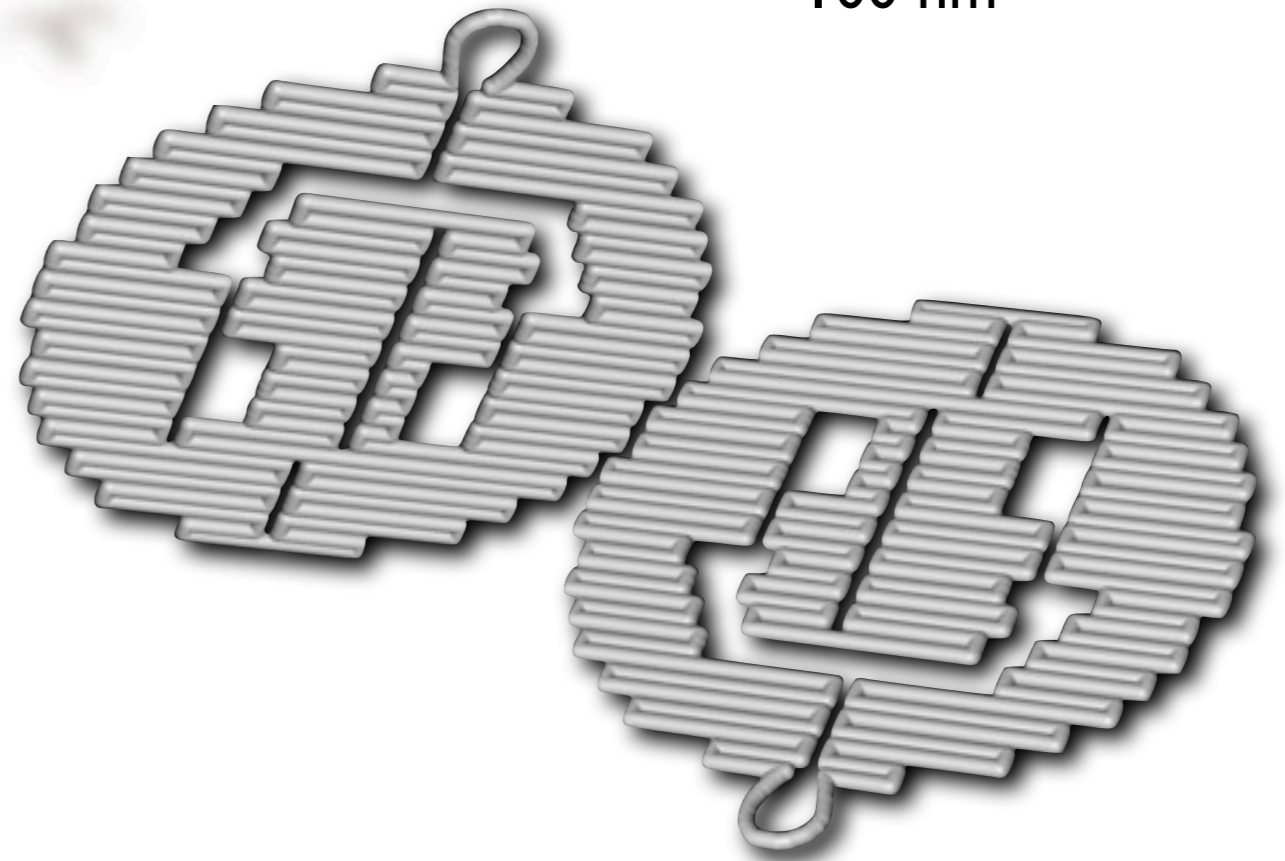

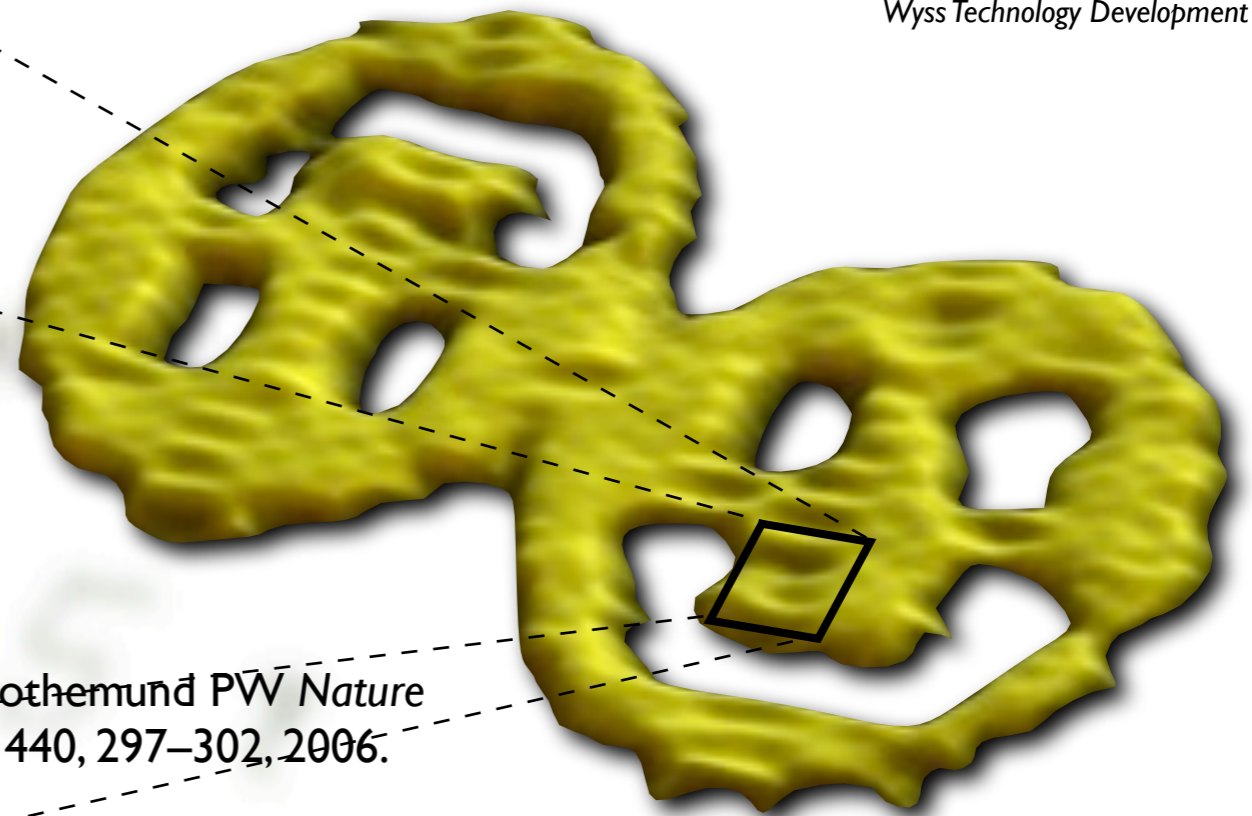
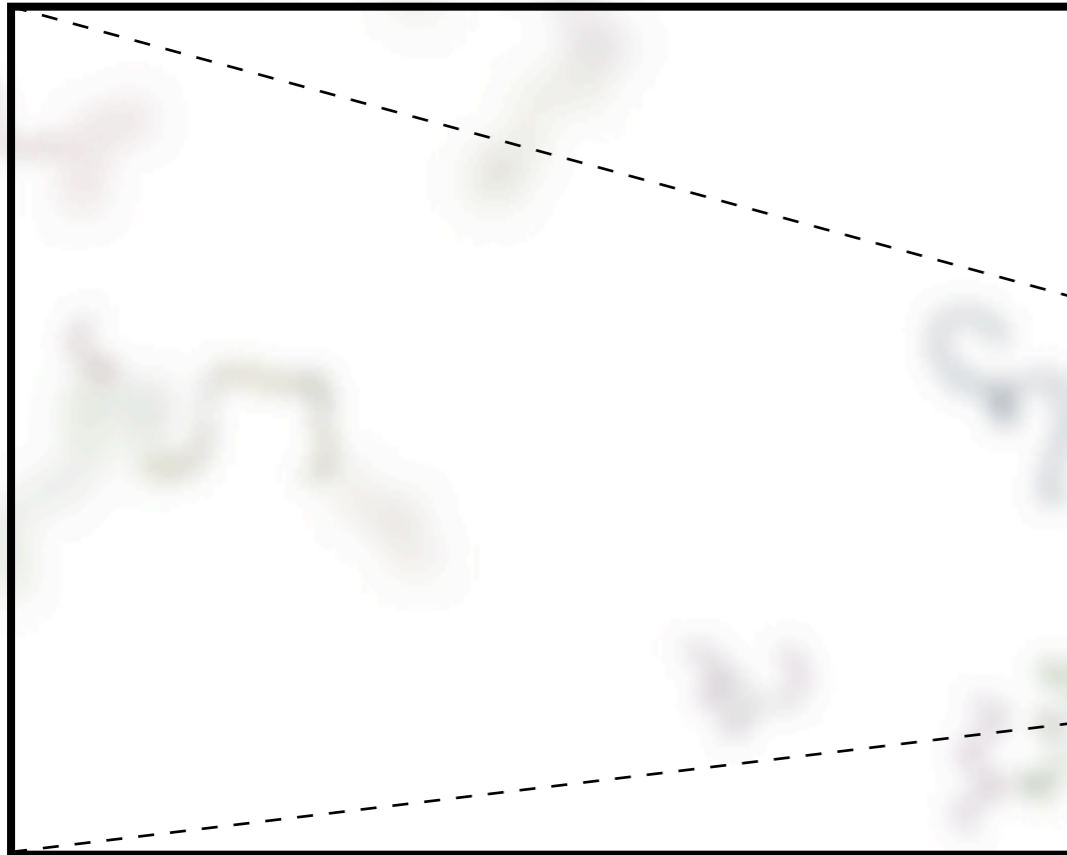

Rothemund PW *Nature*
440, 297–302, 2006.



100 nm

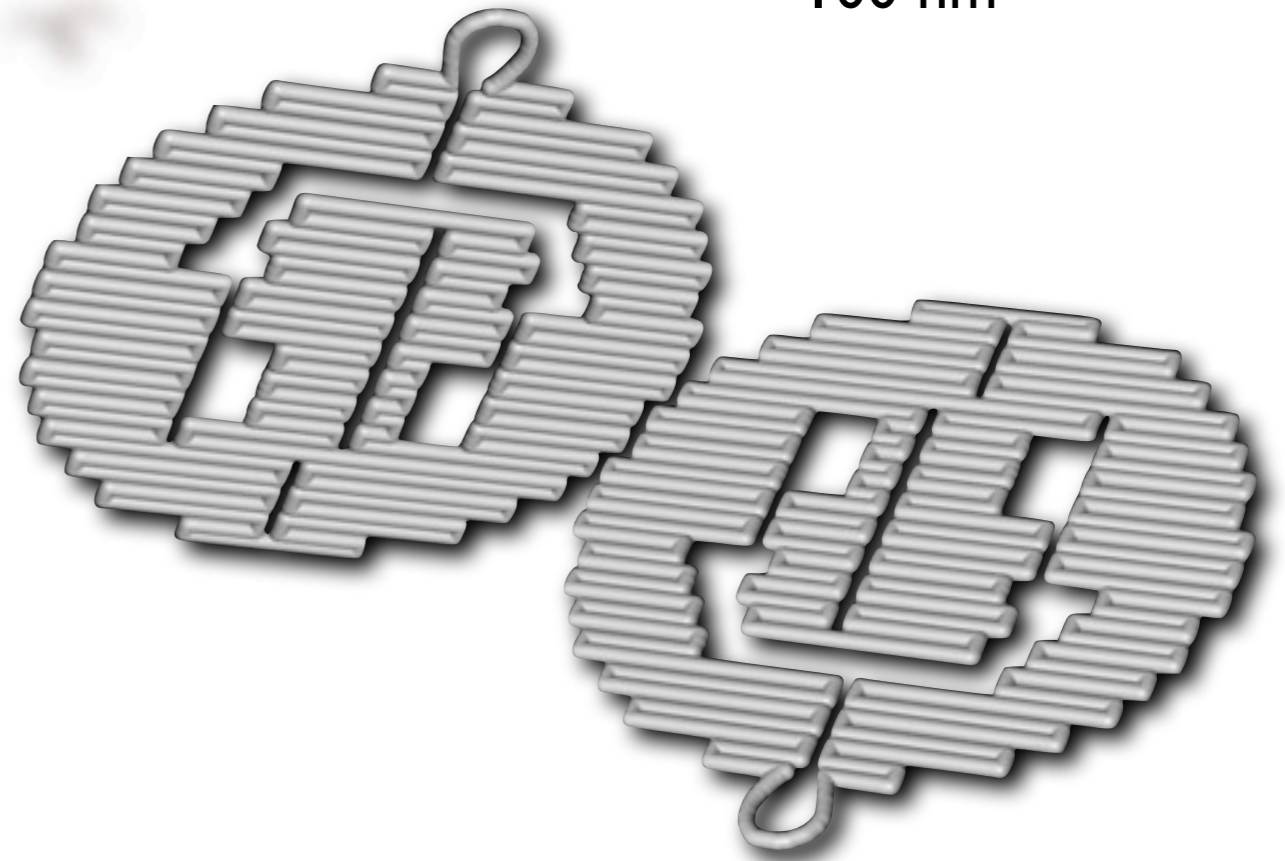

Shawn Douglas

Wyss Technology Development Fellow

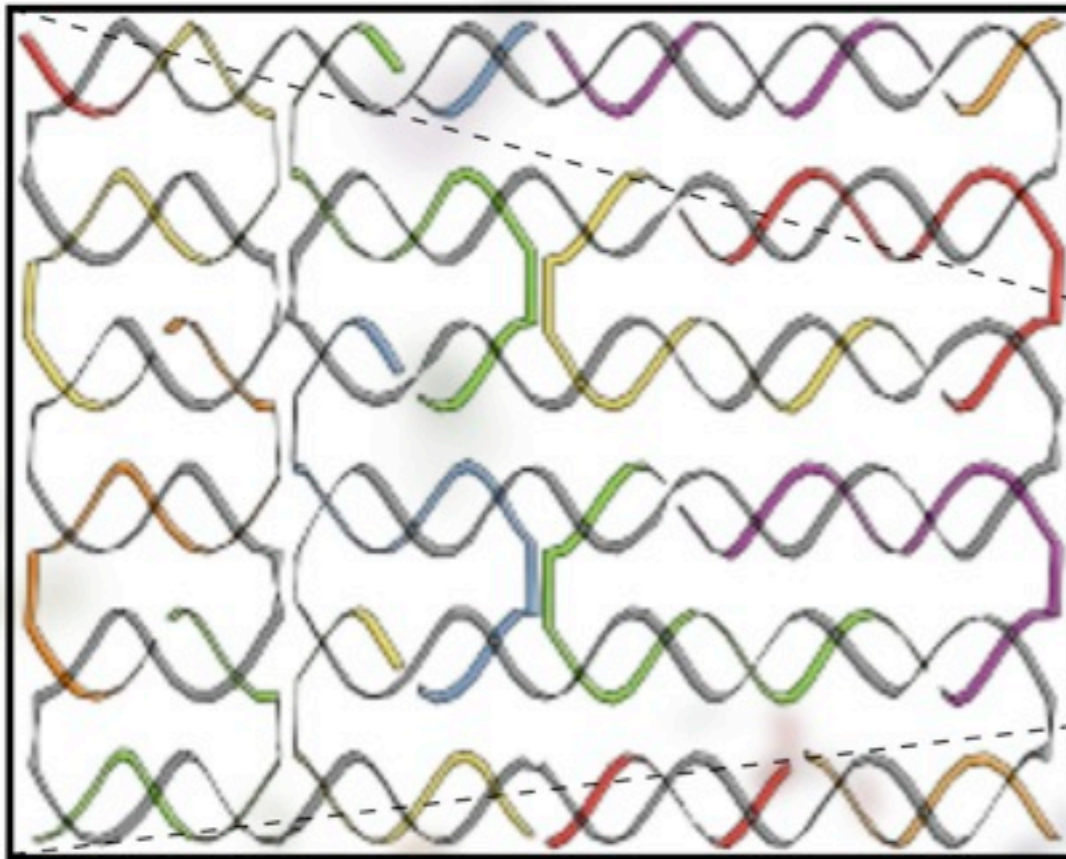

Rothemund PW *Nature*
440, 297–302, 2006.

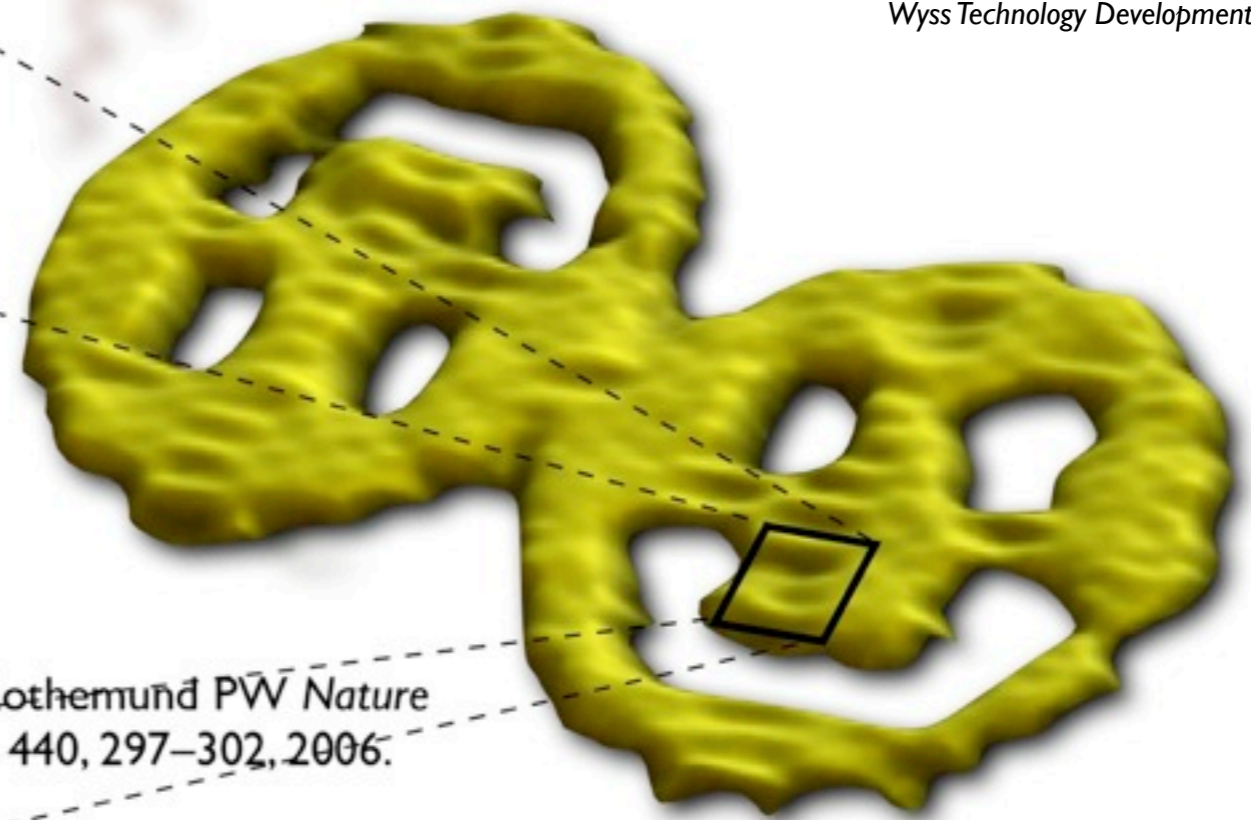

100 nm

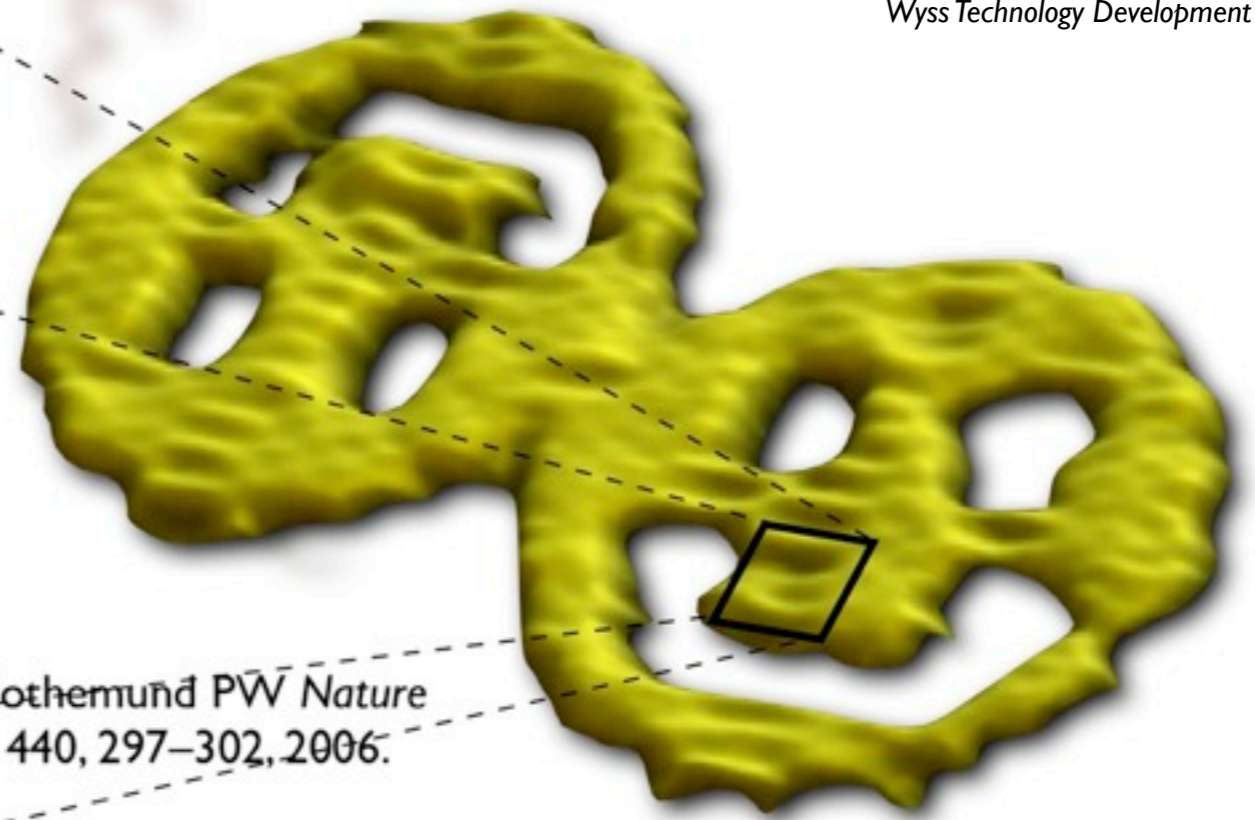
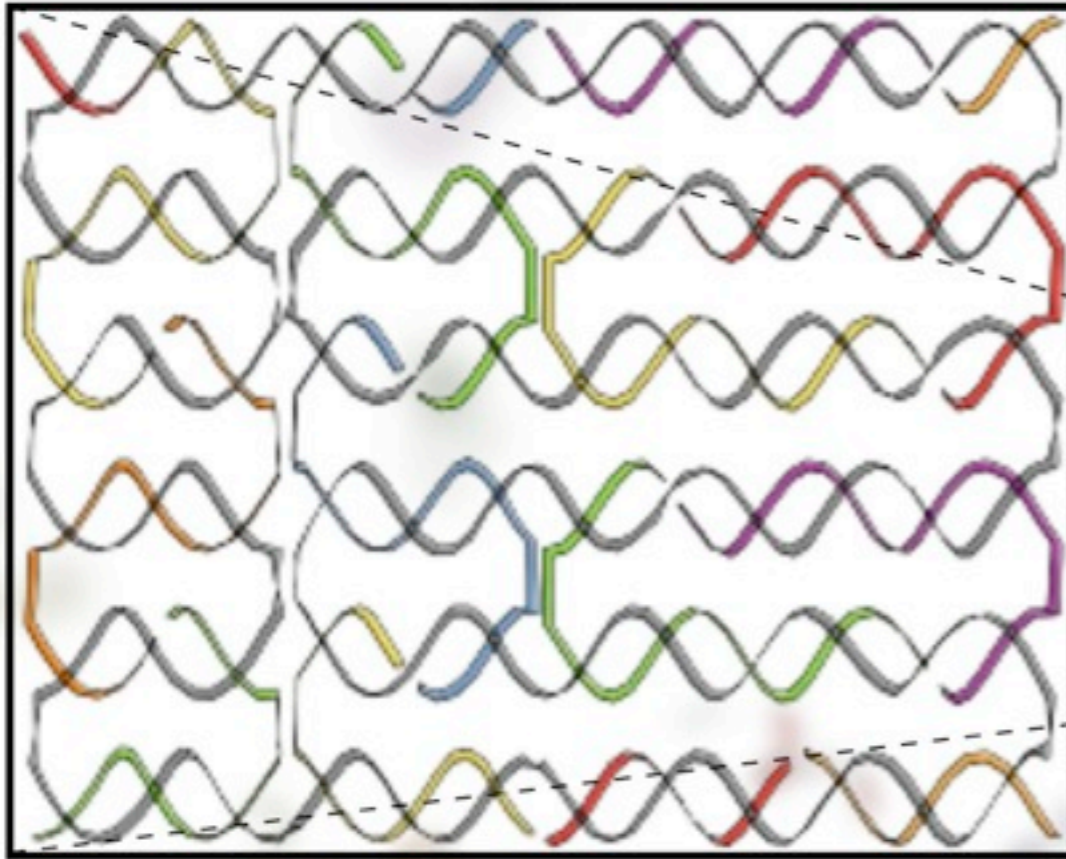

Rothemund PW *Nature*
440, 297–302, 2006.



100 nm

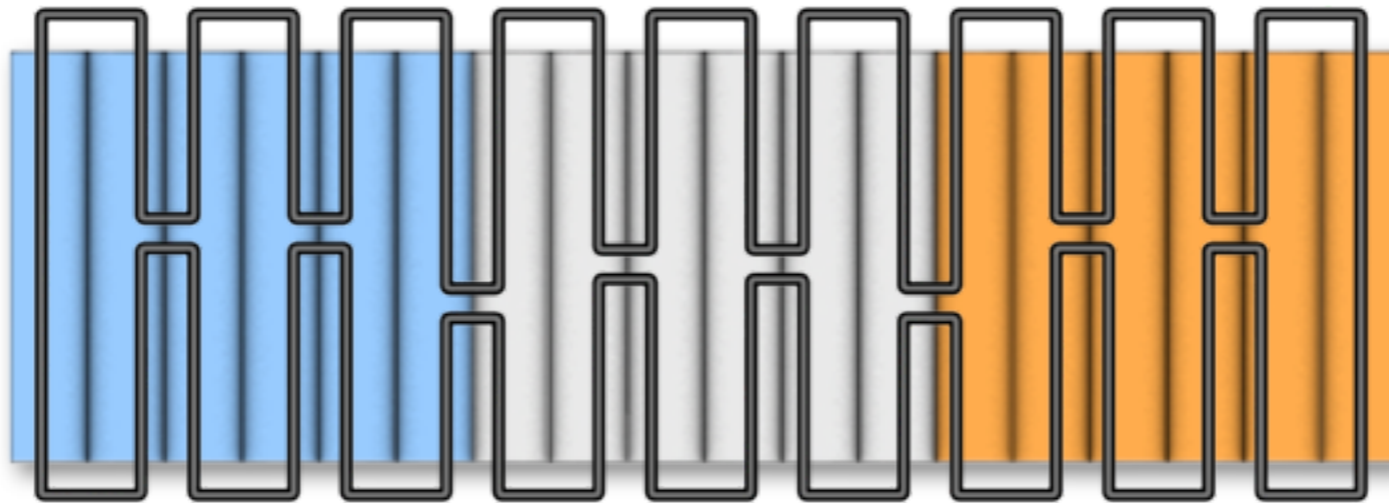

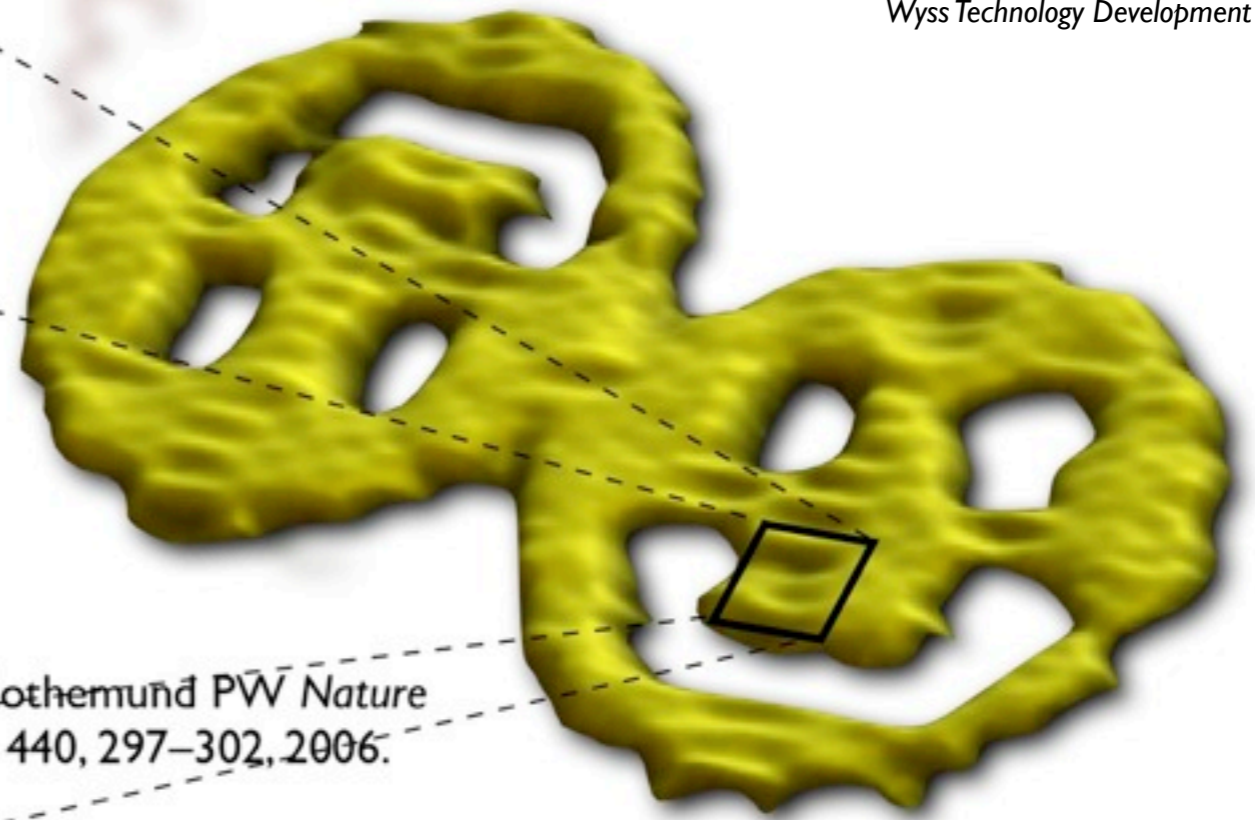
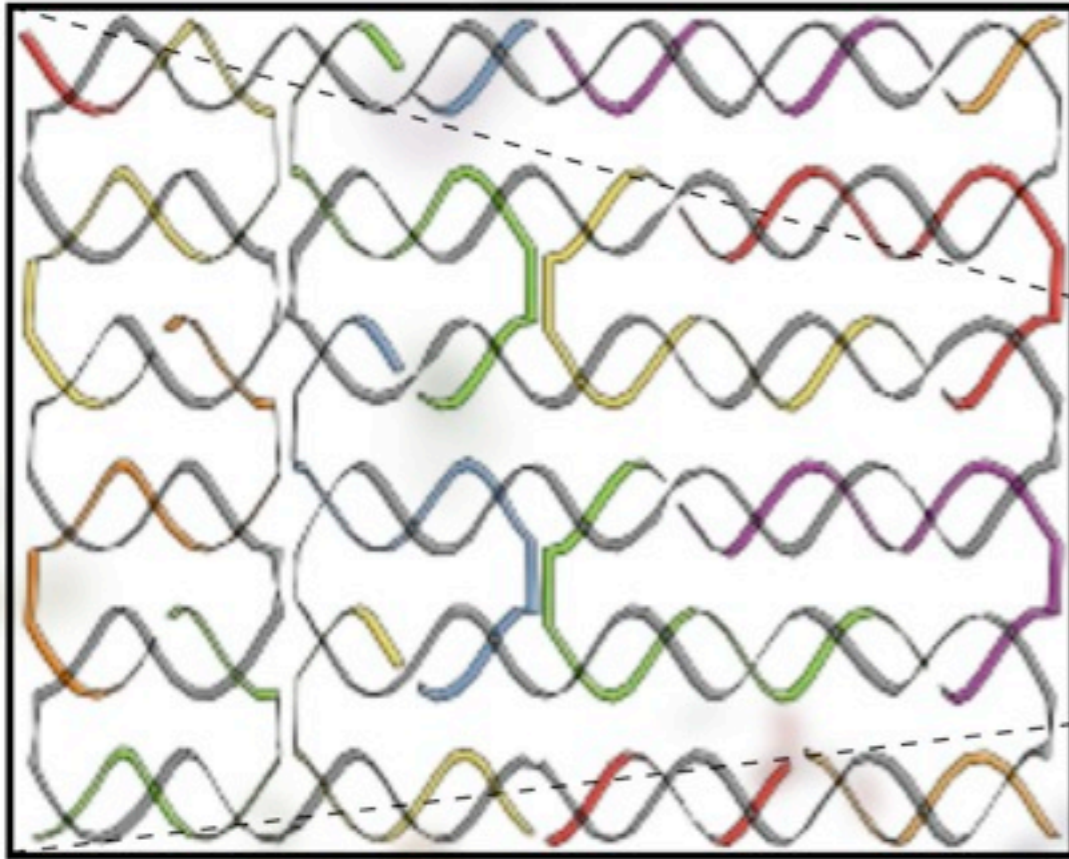

Rothemund PV Nature
440, 297-302, 2006.



100 nm



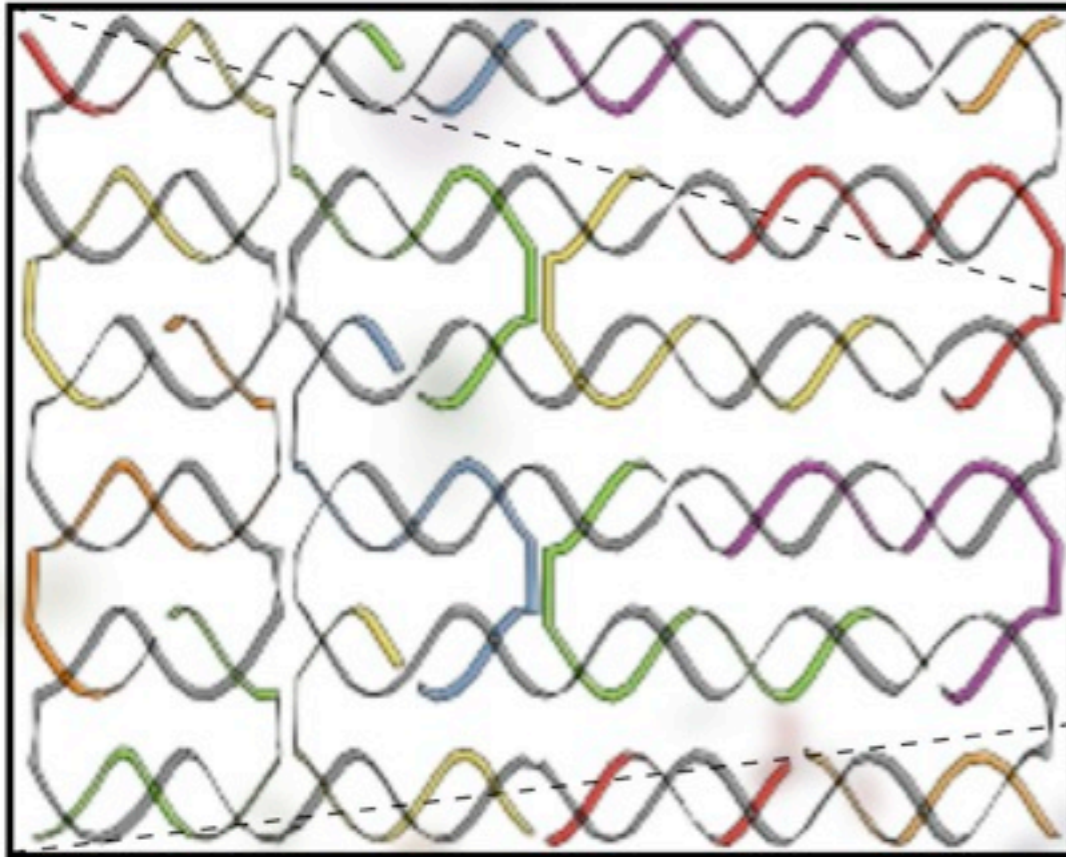

Rothemund PW *Nature*
440, 297–302, 2006.

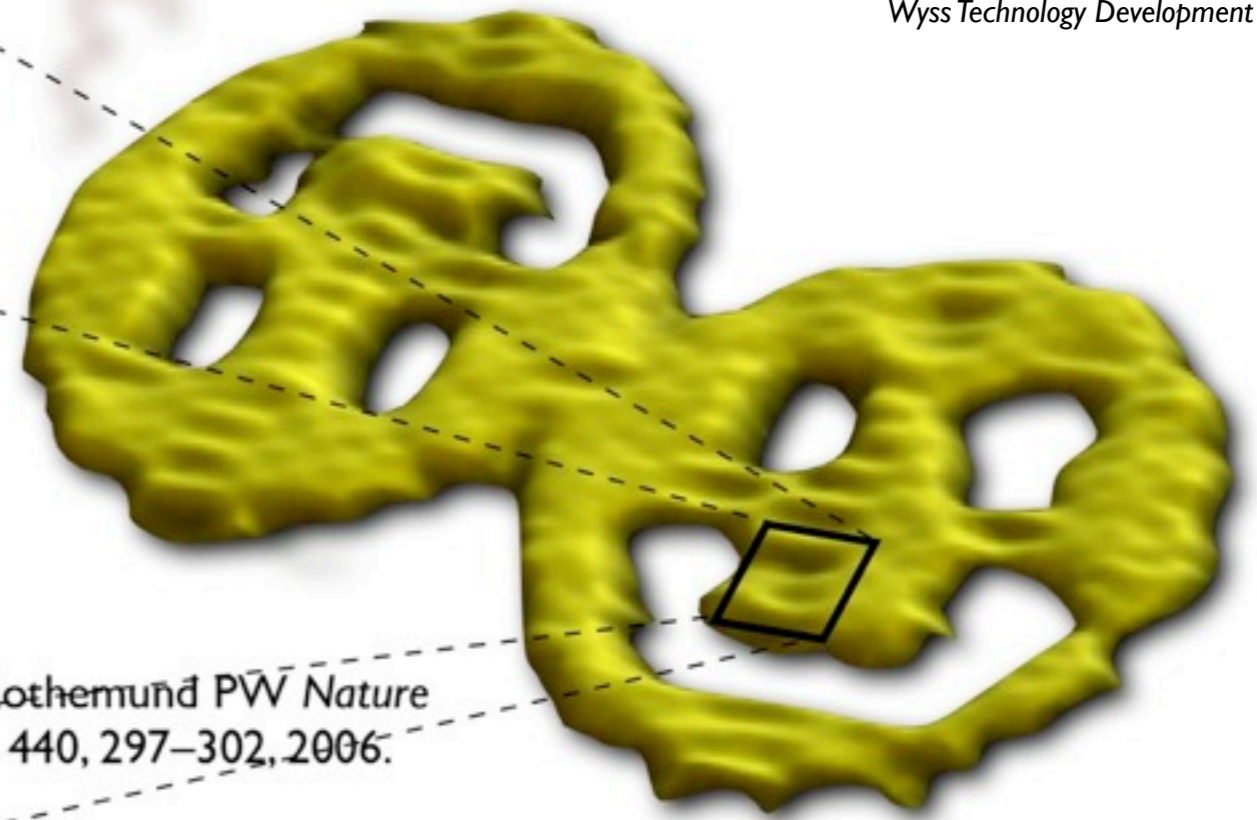

100 nm



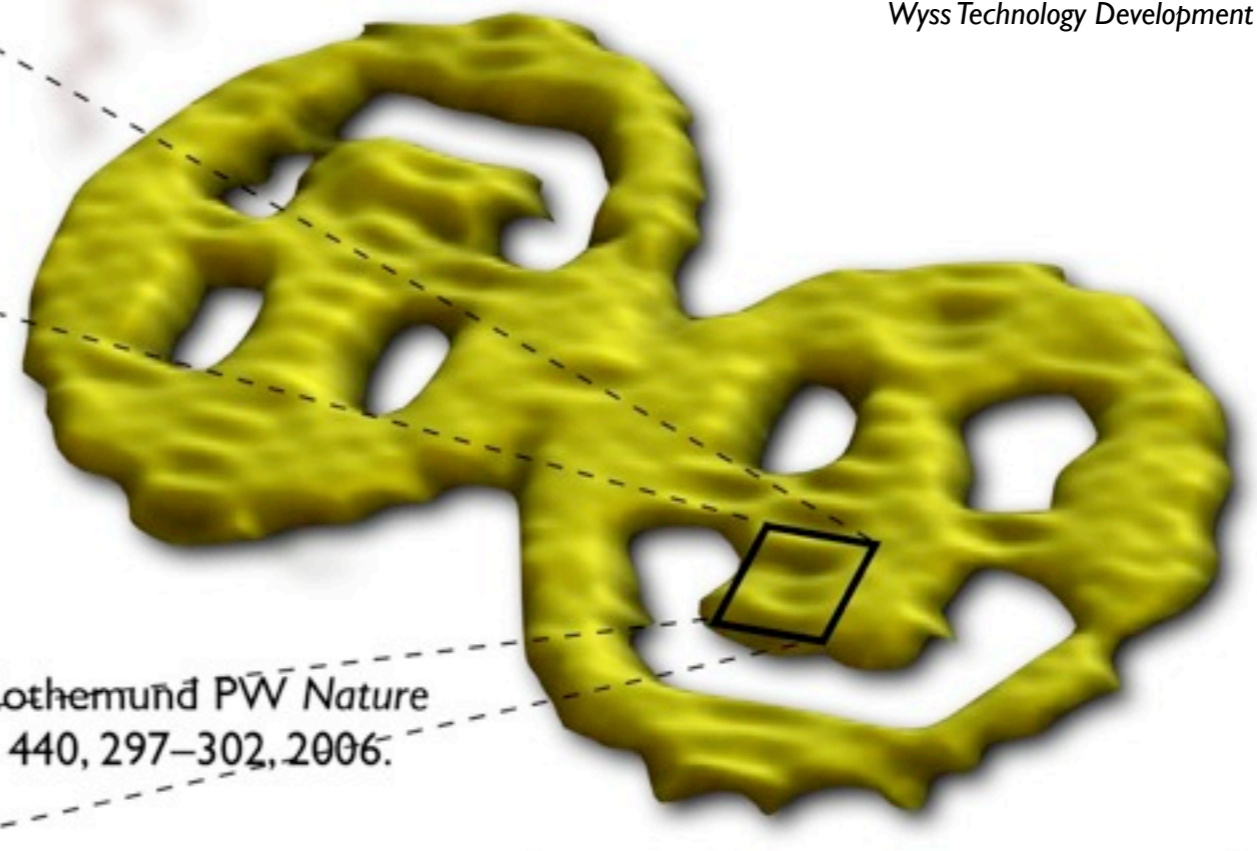
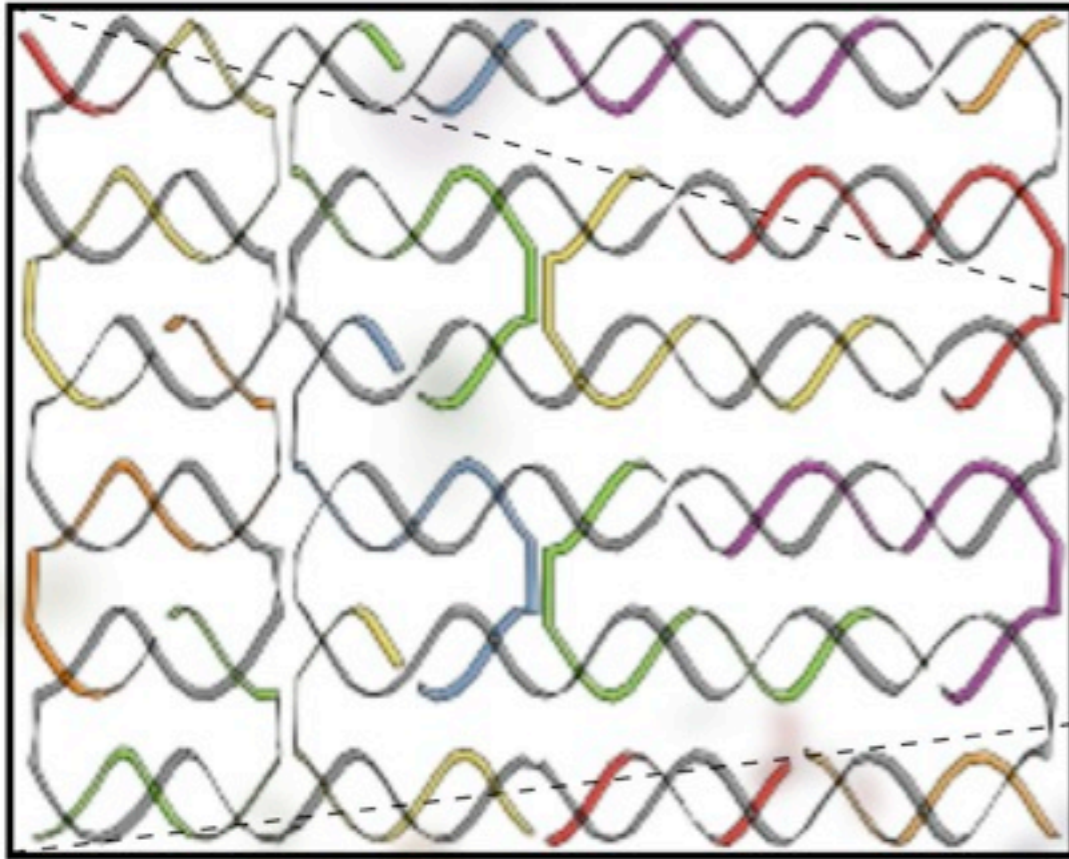

Rothemund PW *Nature*
440, 297–302, 2006.



100 nm



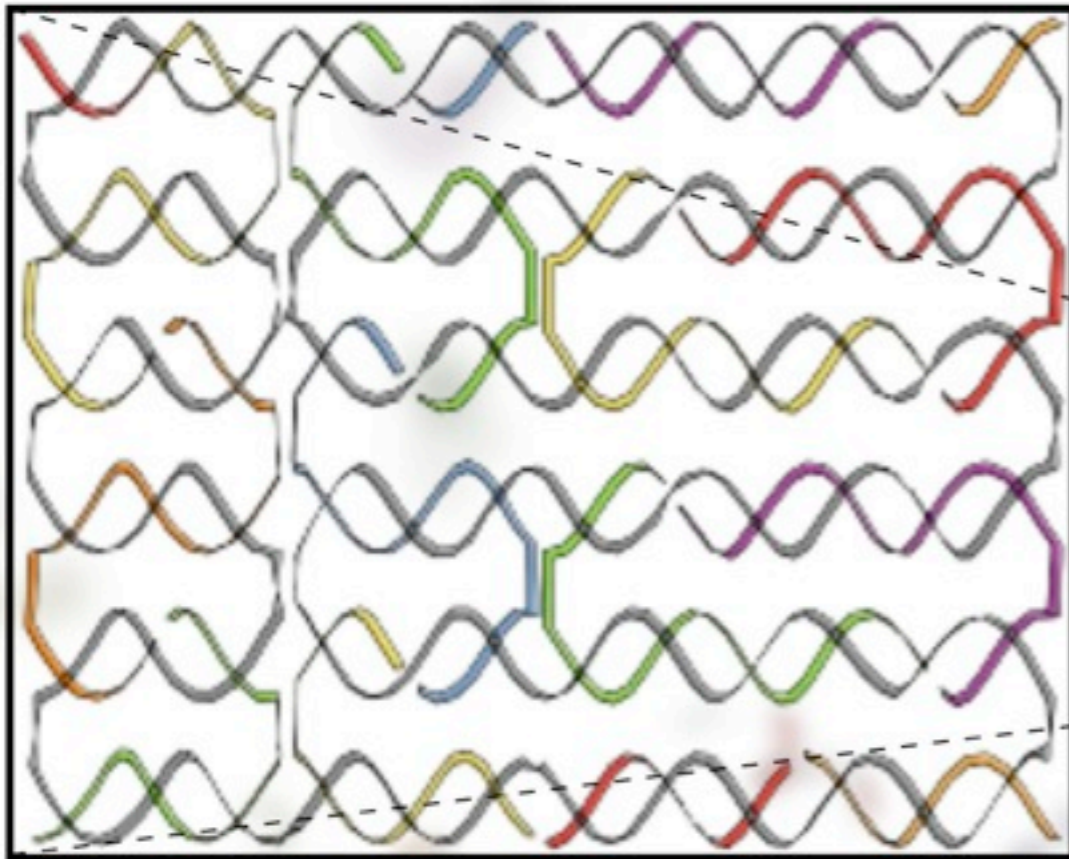

Rothemund PW *Nature*
440, 297–302, 2006.

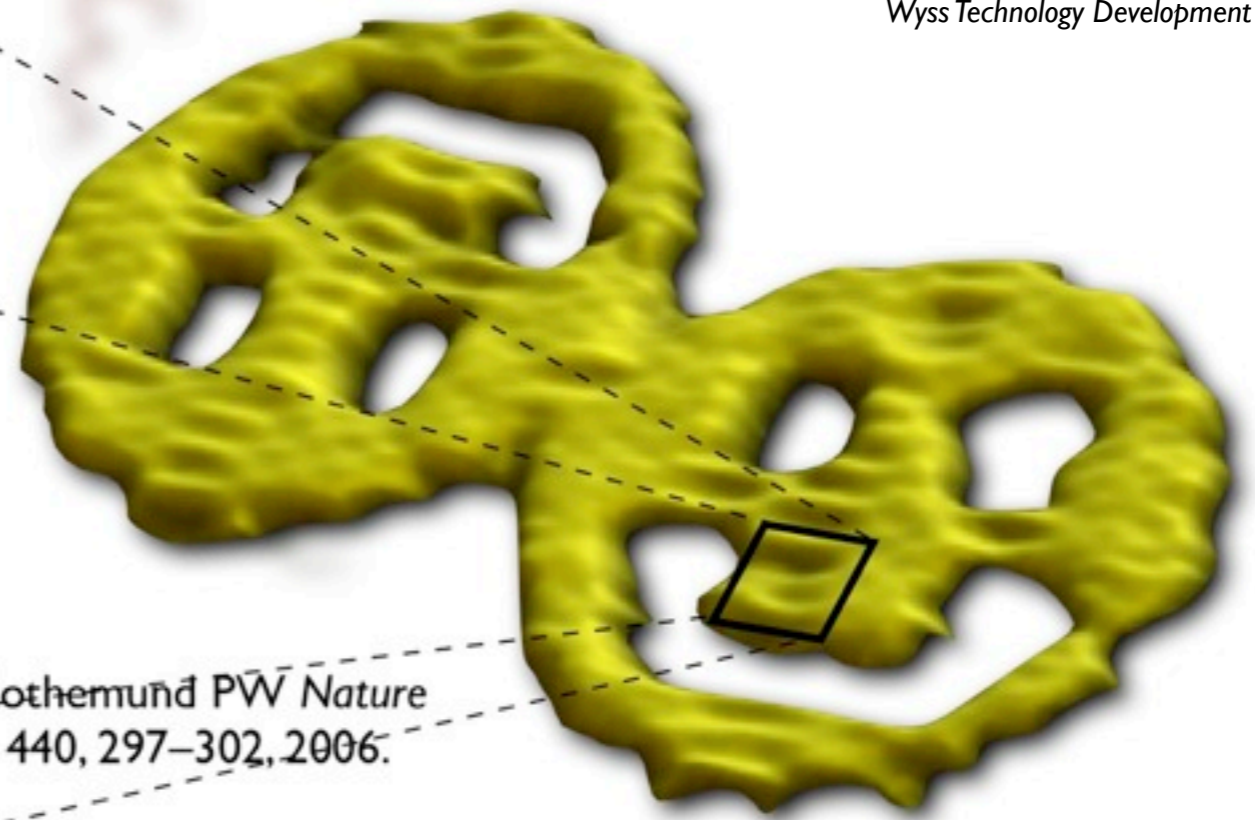

100 nm



10 nm

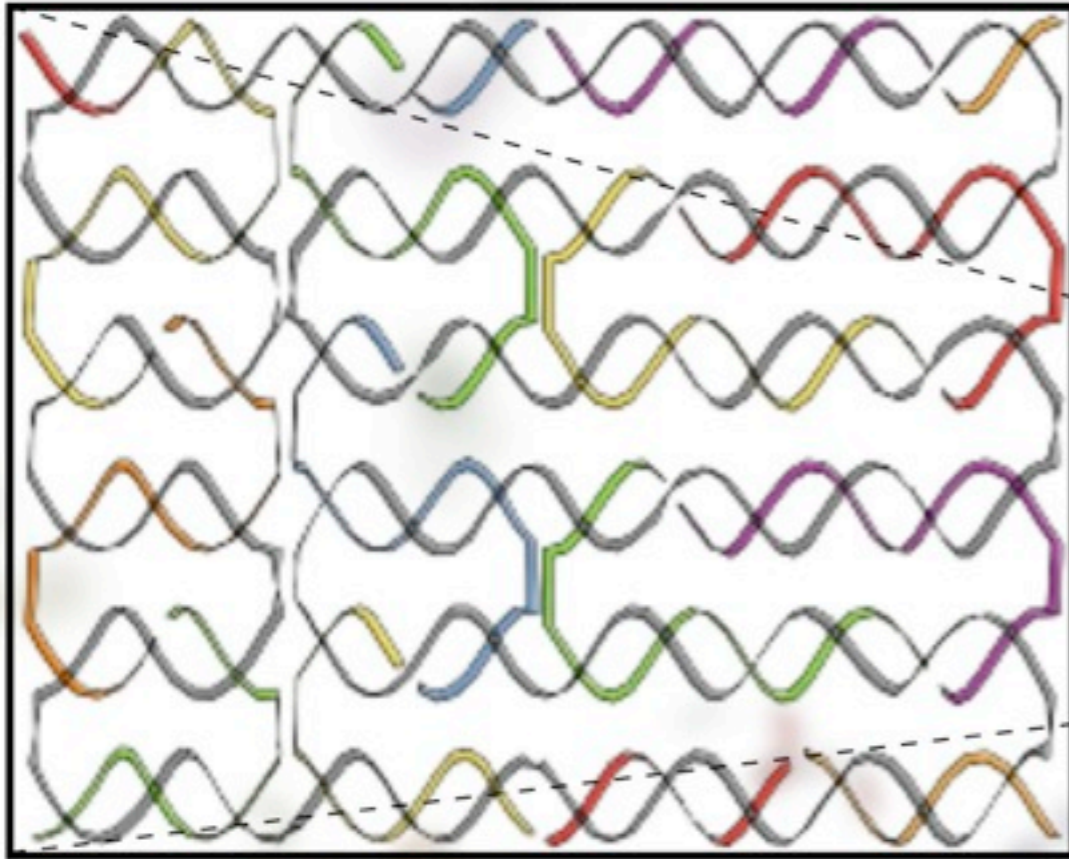

Rothemund PW *Nature*
440, 297–302, 2006.

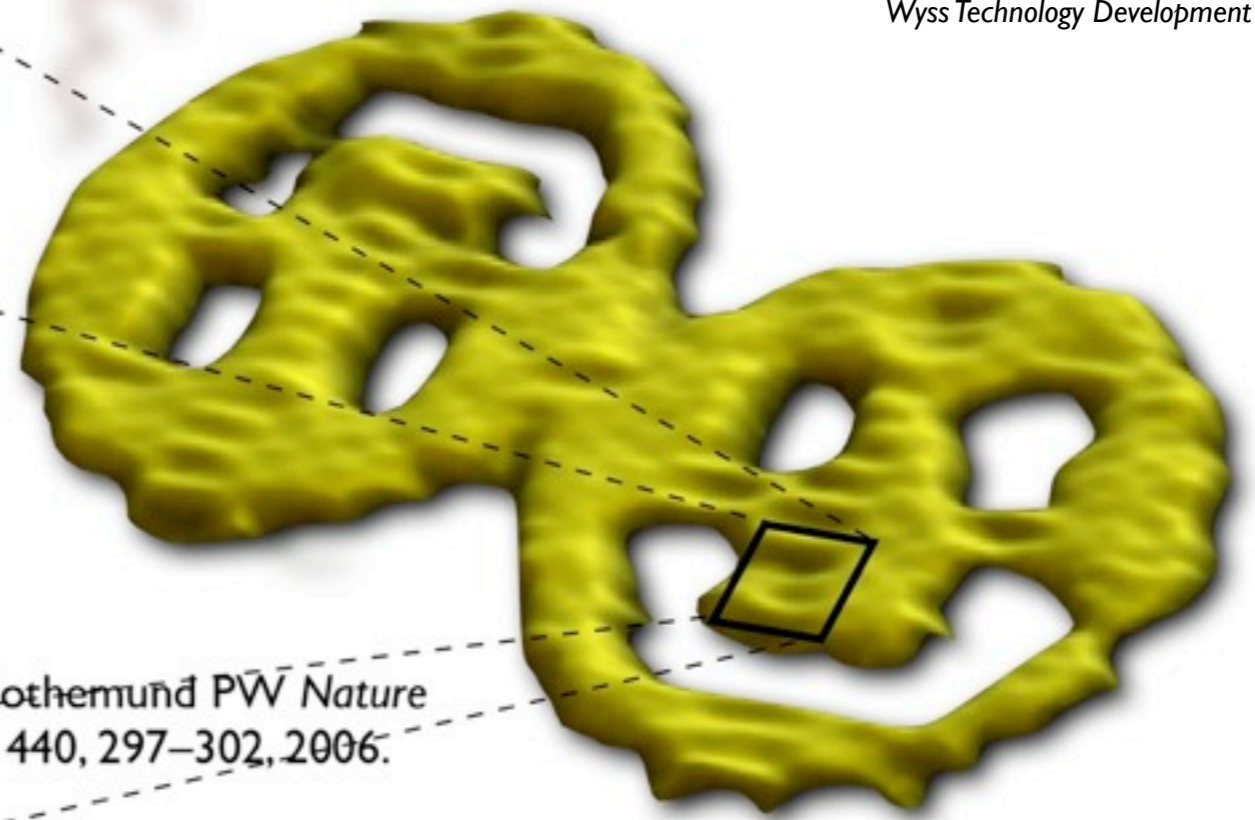

100 nm

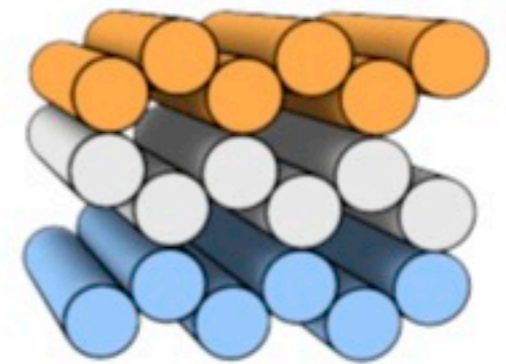

10 nm

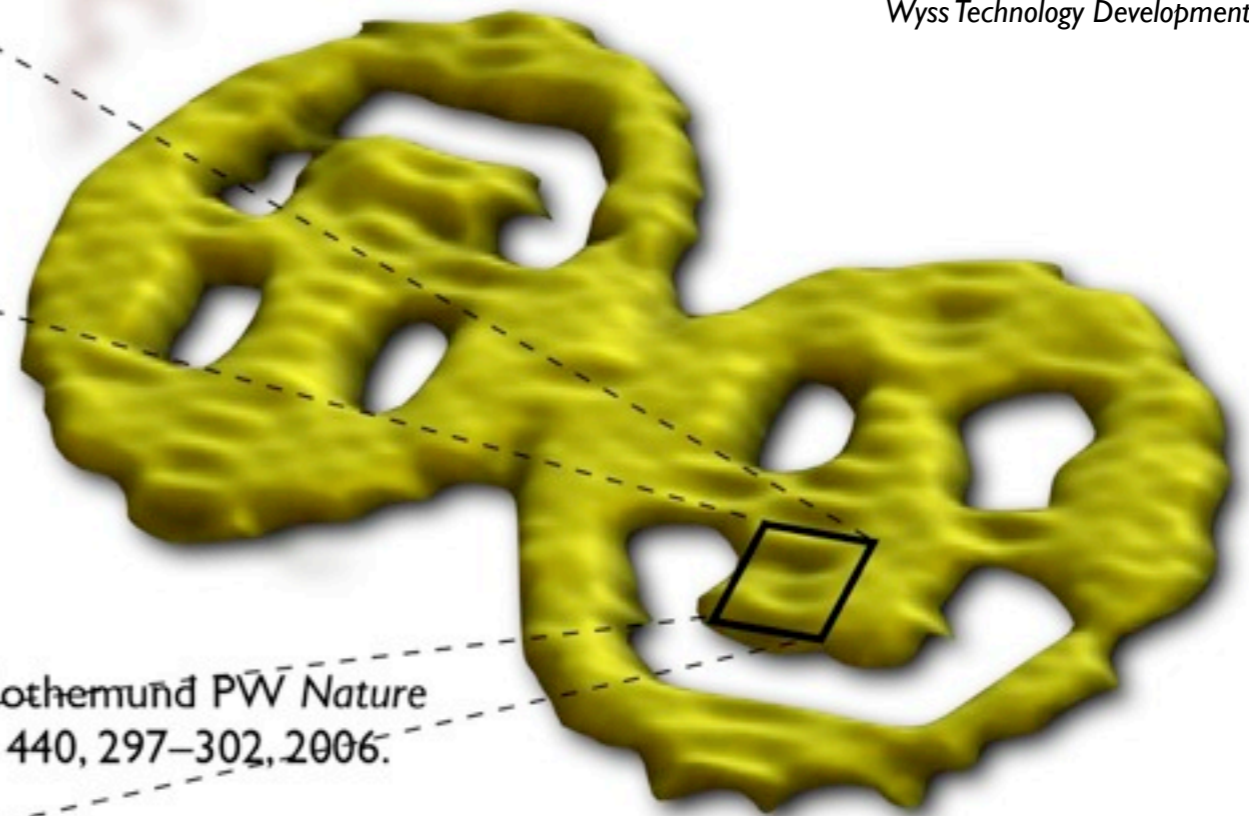
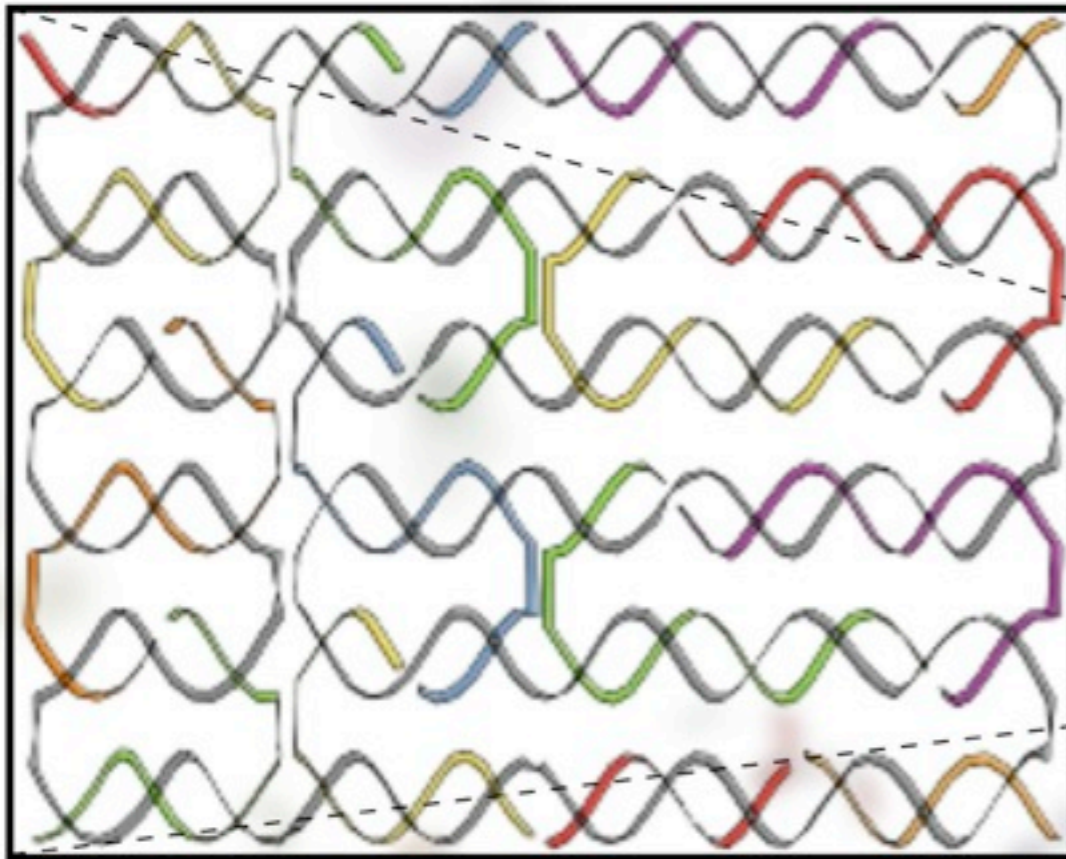

Rothemund PW *Nature*
440, 297–302, 2006.

100 nm

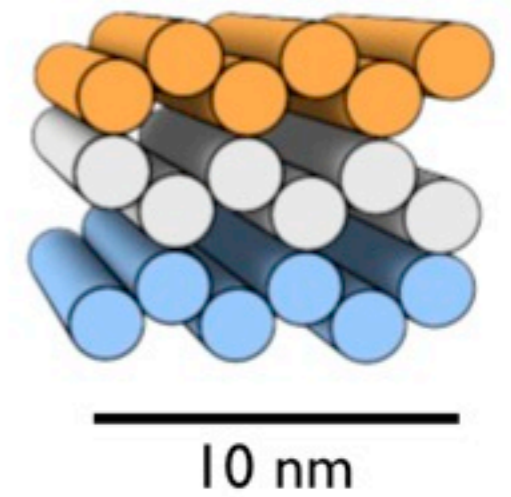
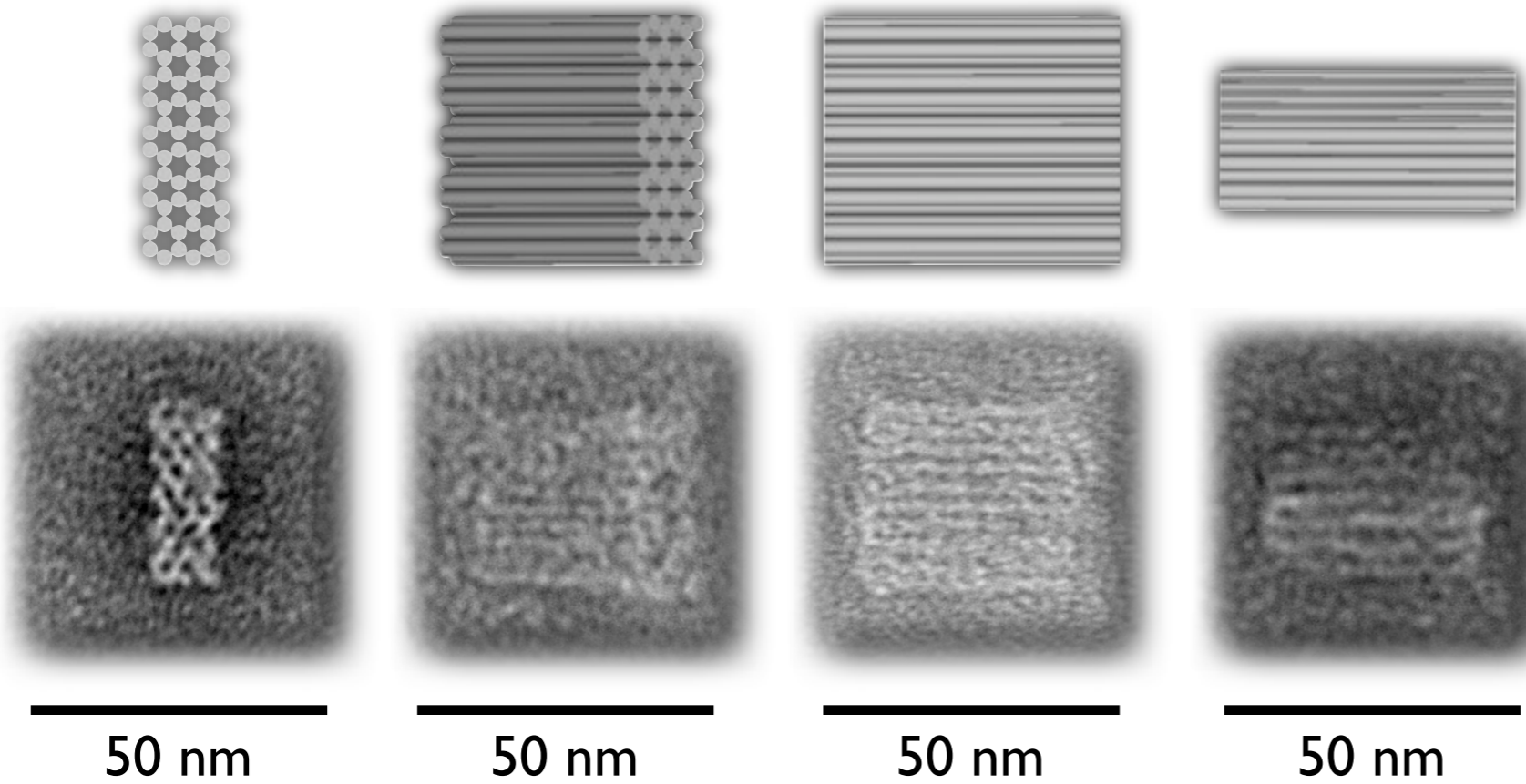

10 nm

“Monolith”

Shawn Douglas

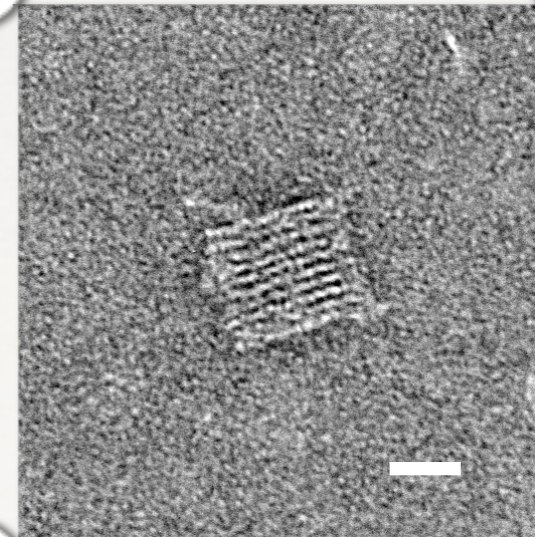
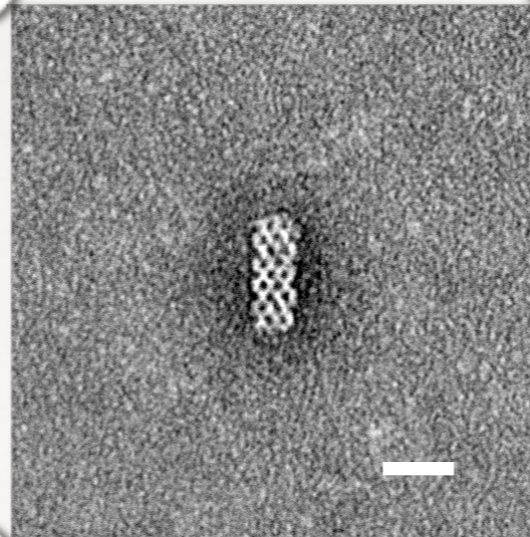
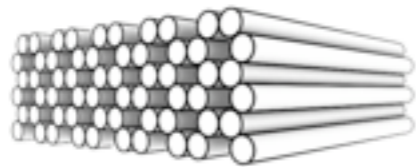

“Genie Bottle”

Franziska Graf

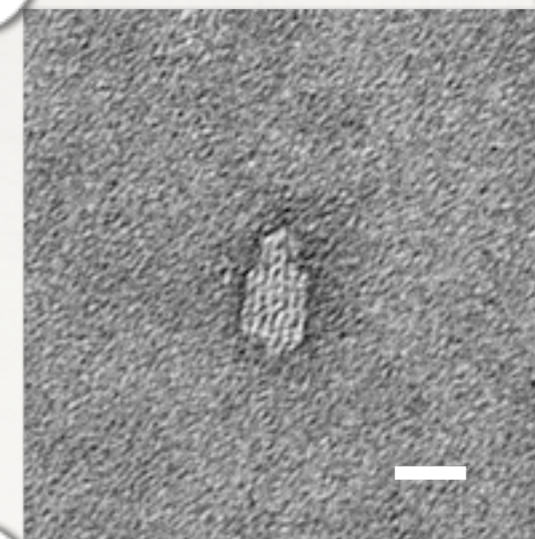
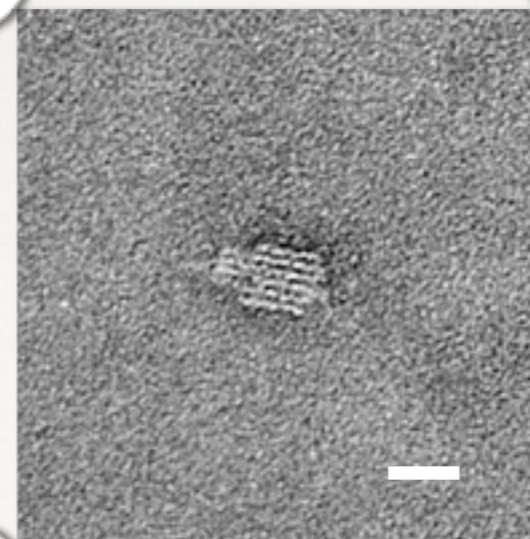
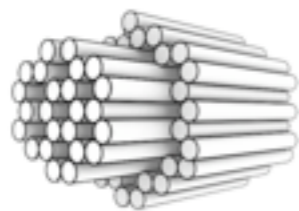

“Square Nut”

Shawn Douglas

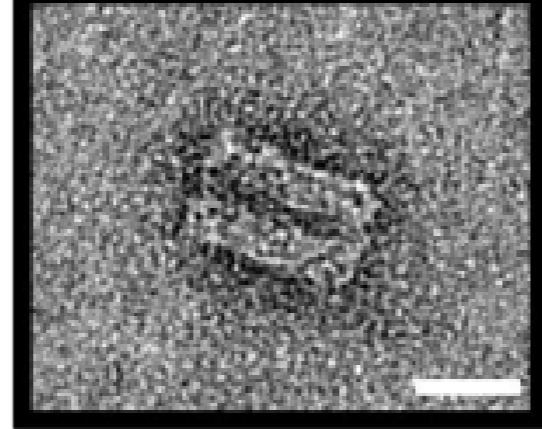
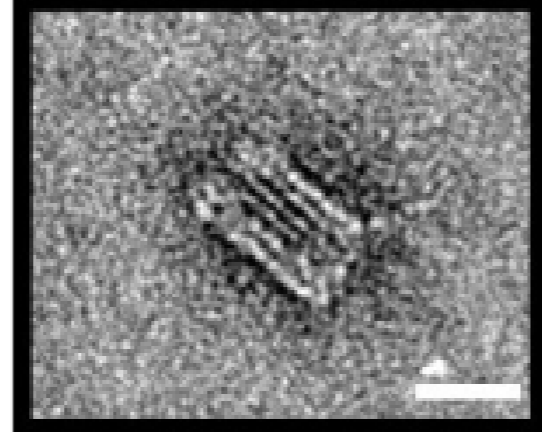
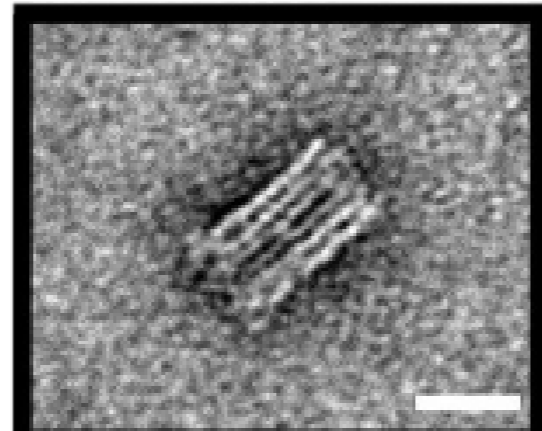
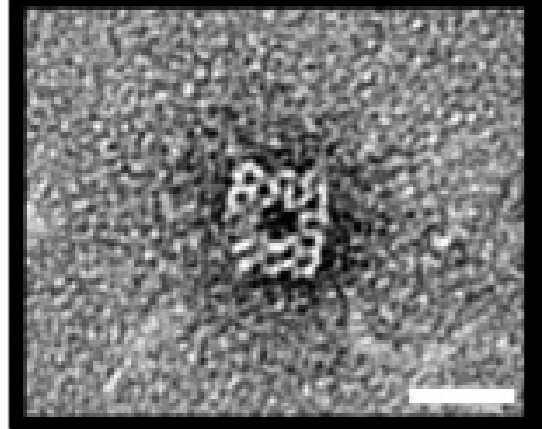
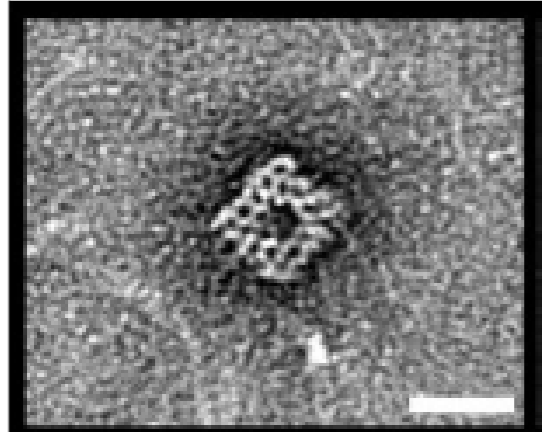
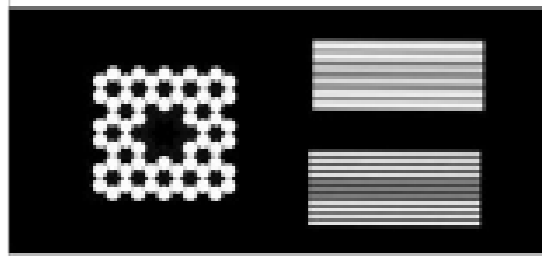
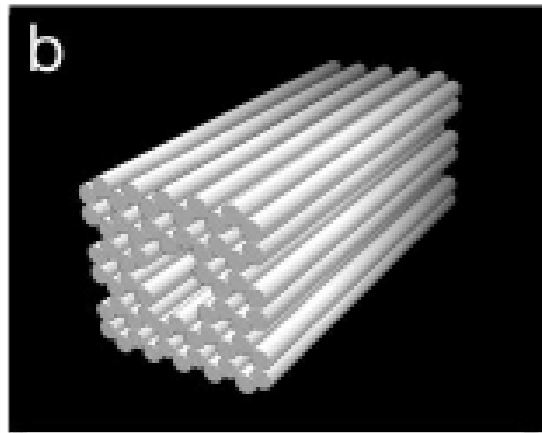
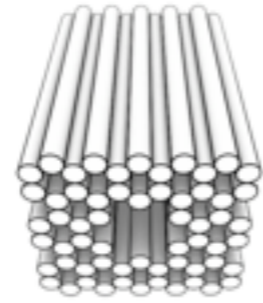

“Railed Bridge”

Tim Liedl

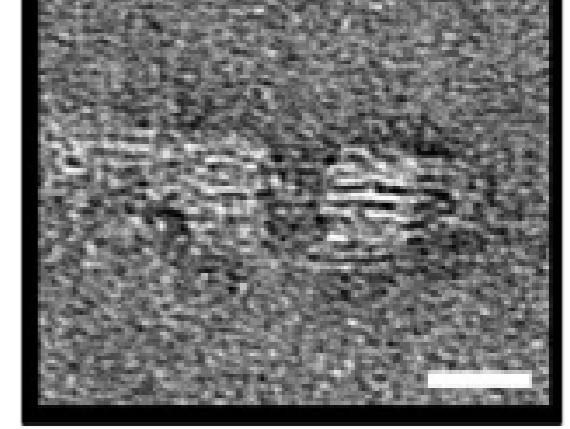
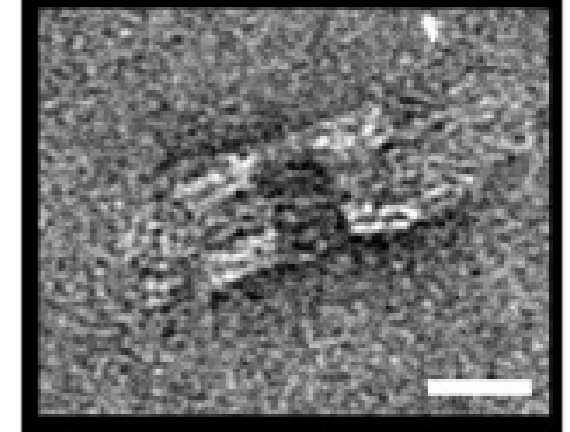
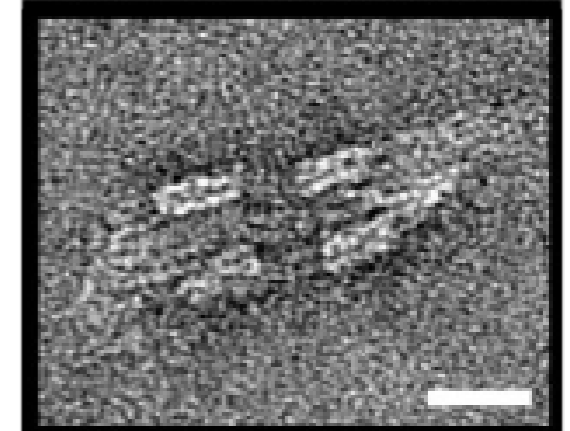
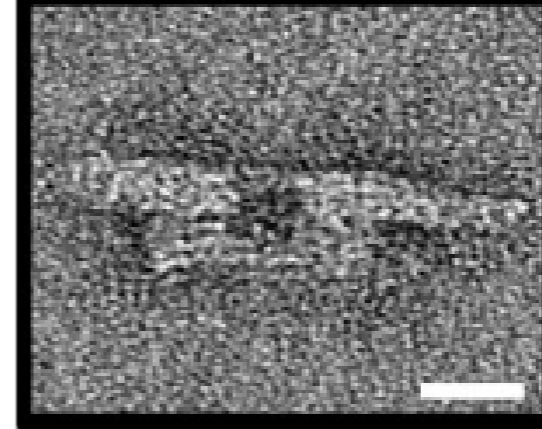
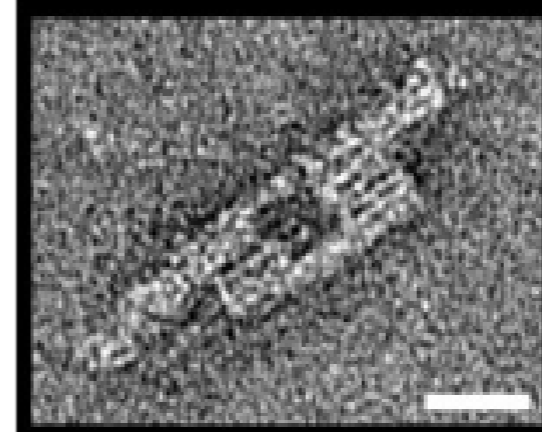
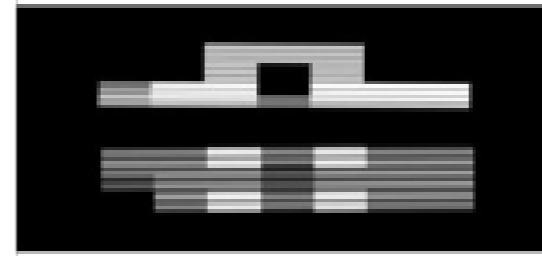
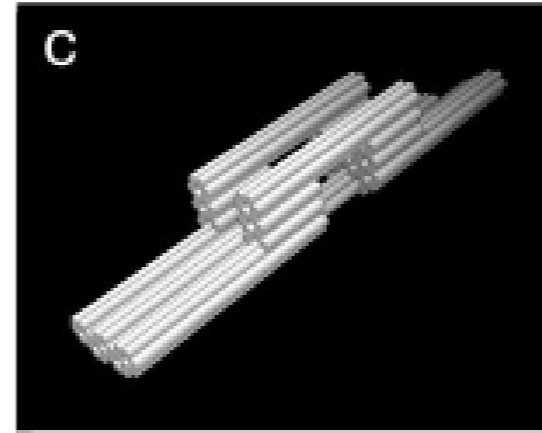
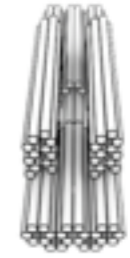

“Slotted Cross”

Björn Högberg

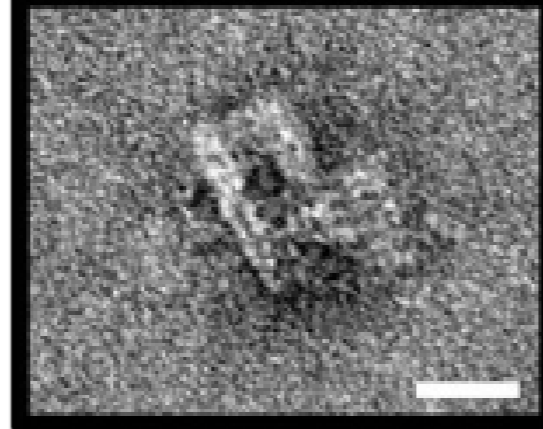
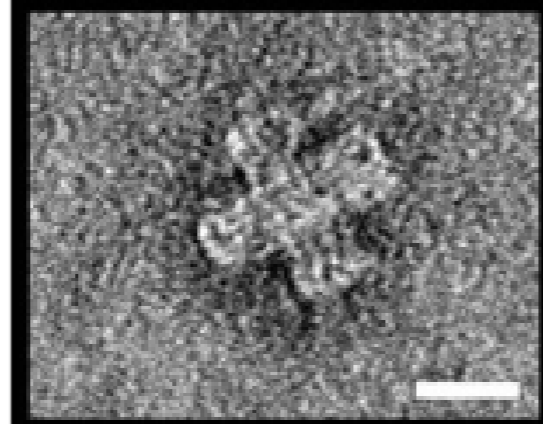
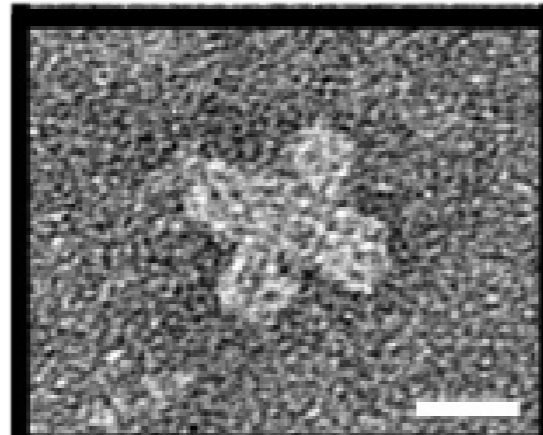
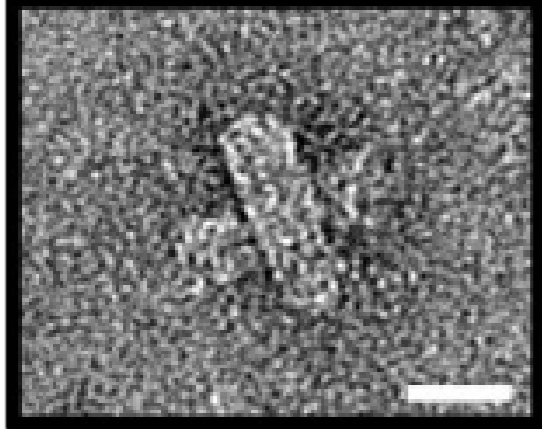
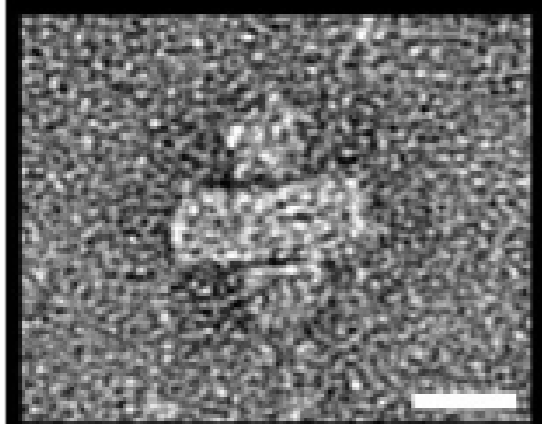
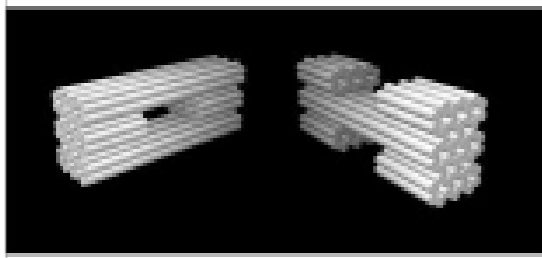
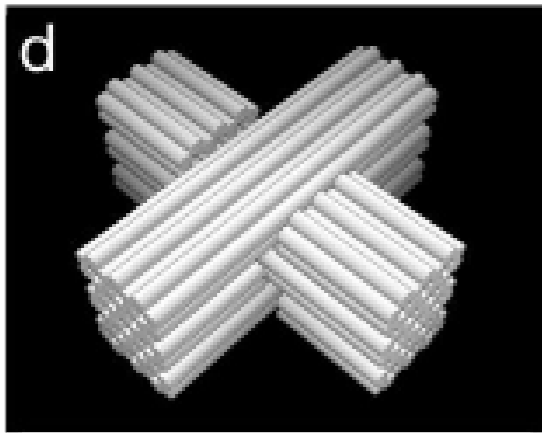
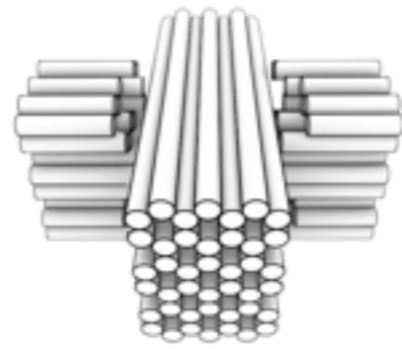

“Stacked Cross”

Hendrik Dietz

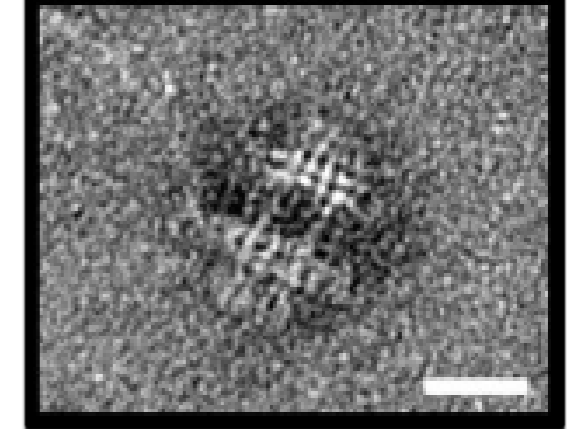
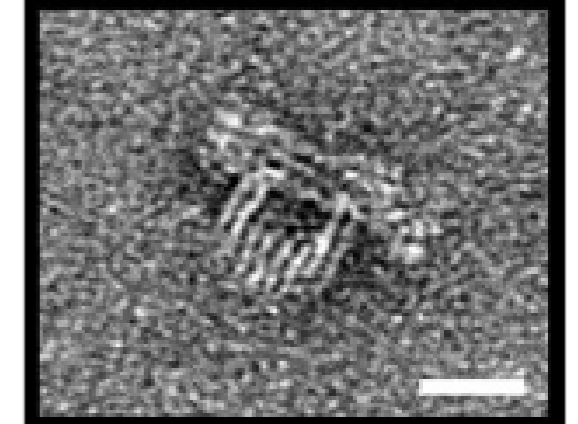
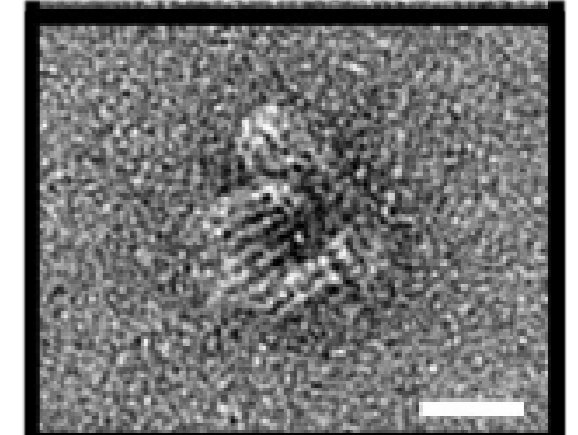
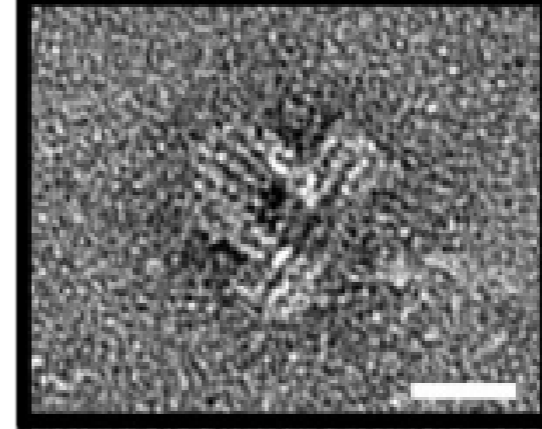
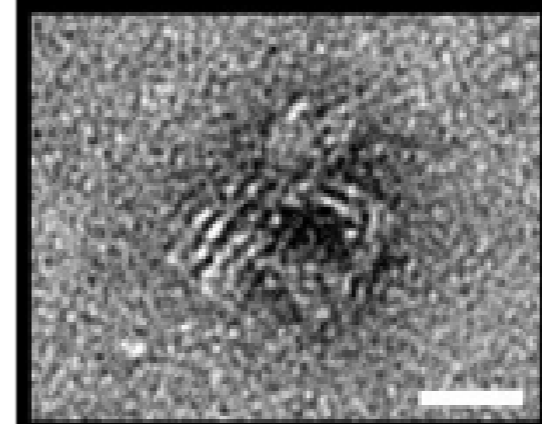
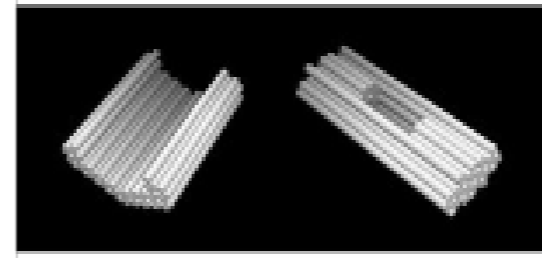
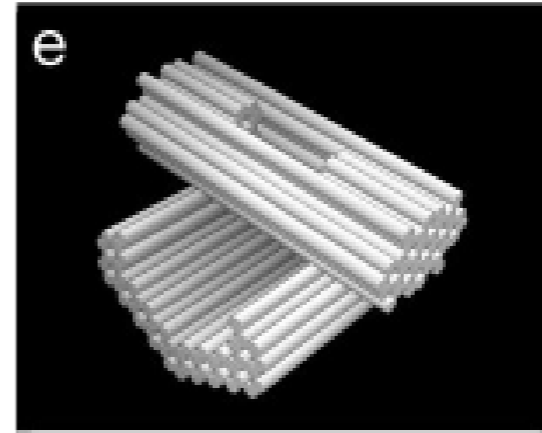
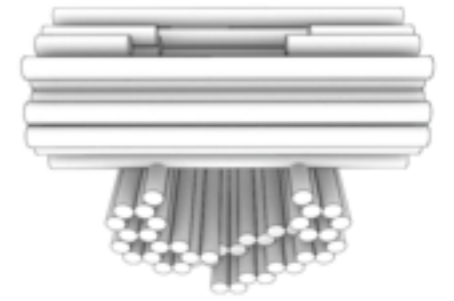

“Slotted Cross”

Björn Högberg

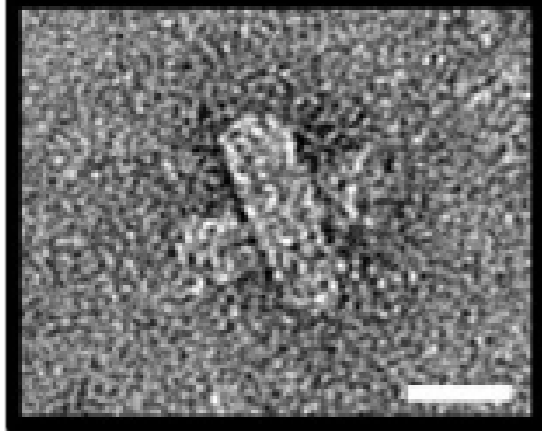
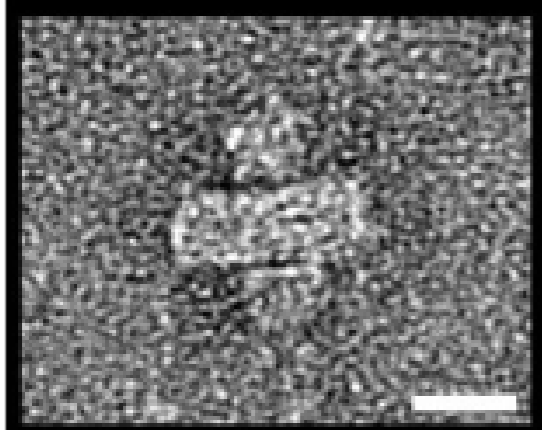
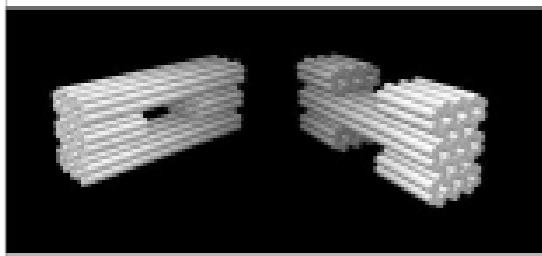
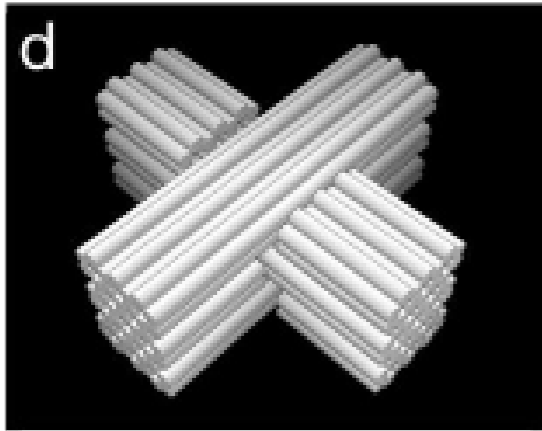

“Slotted Cross”

Björn Högberg

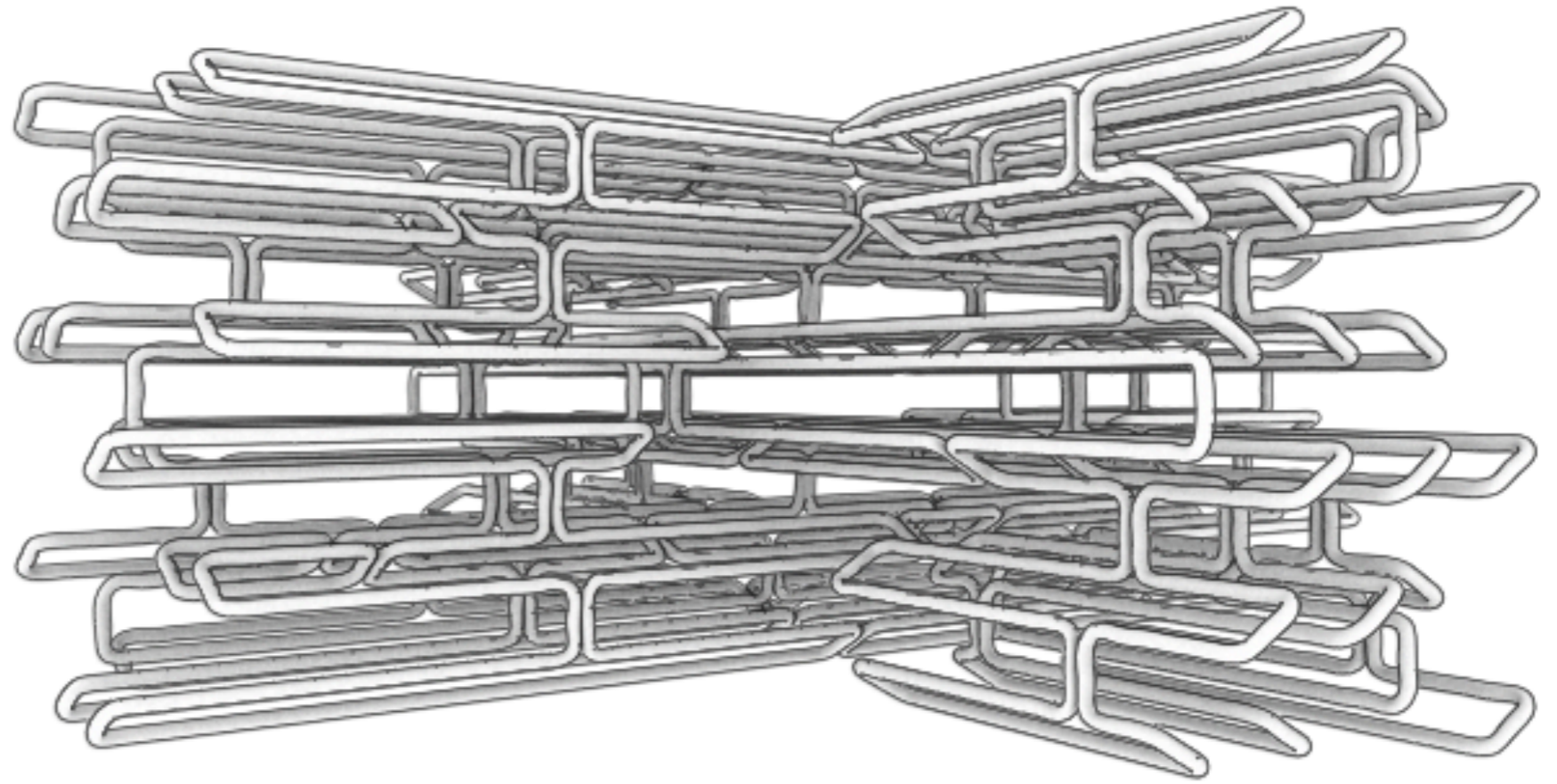
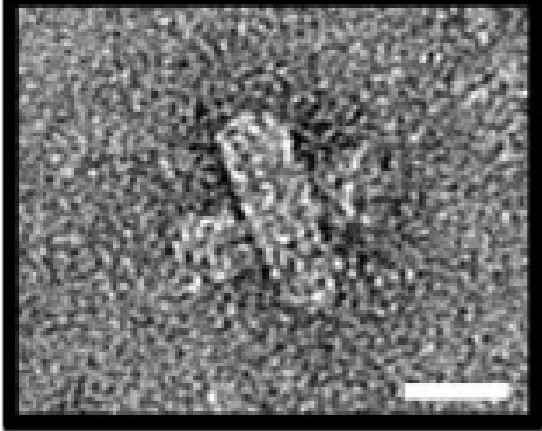
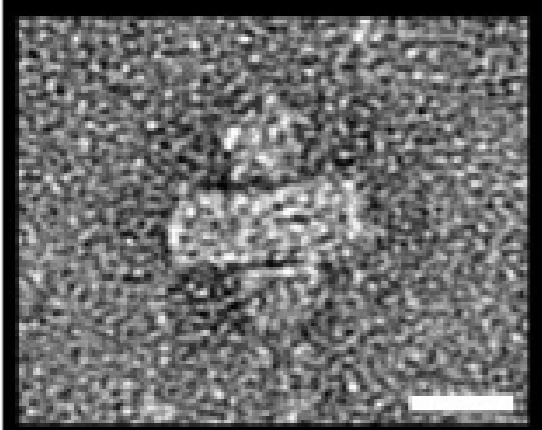
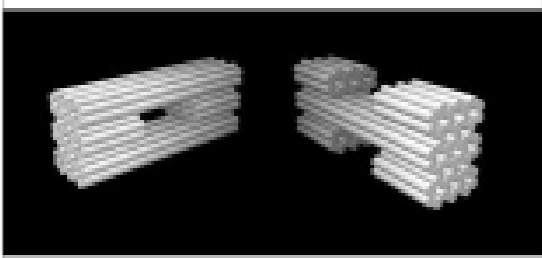
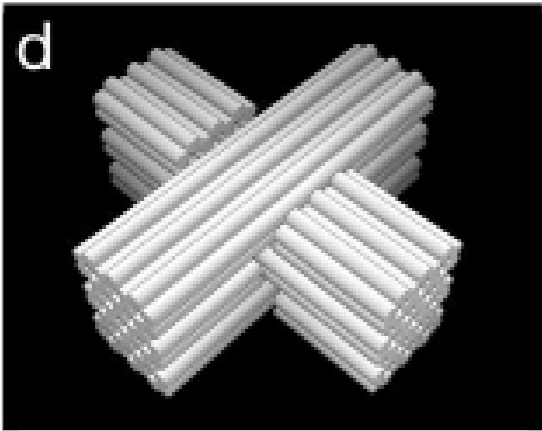

“Slotted Cross”

Björn Högberg

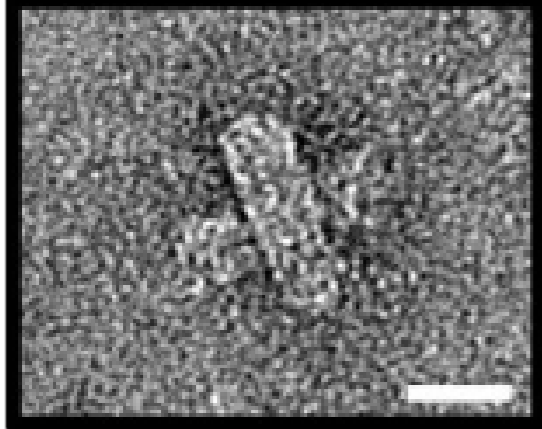
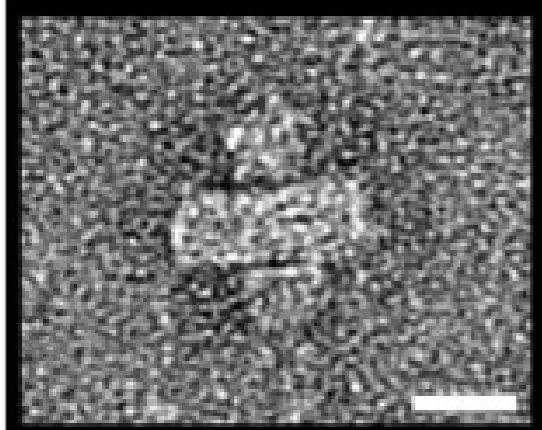
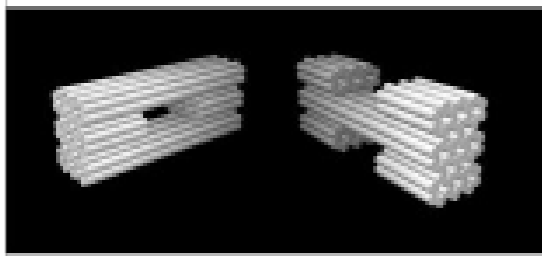
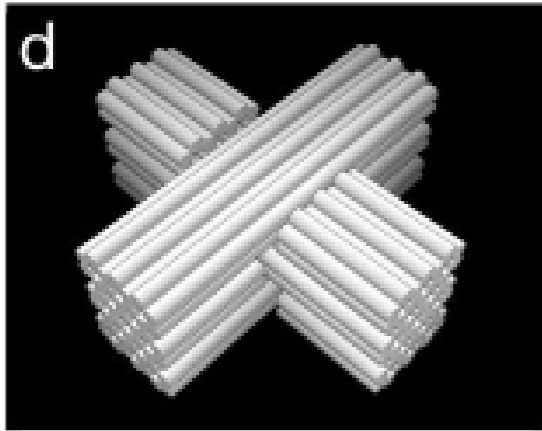

“Slotted Cross”

Björn Högberg

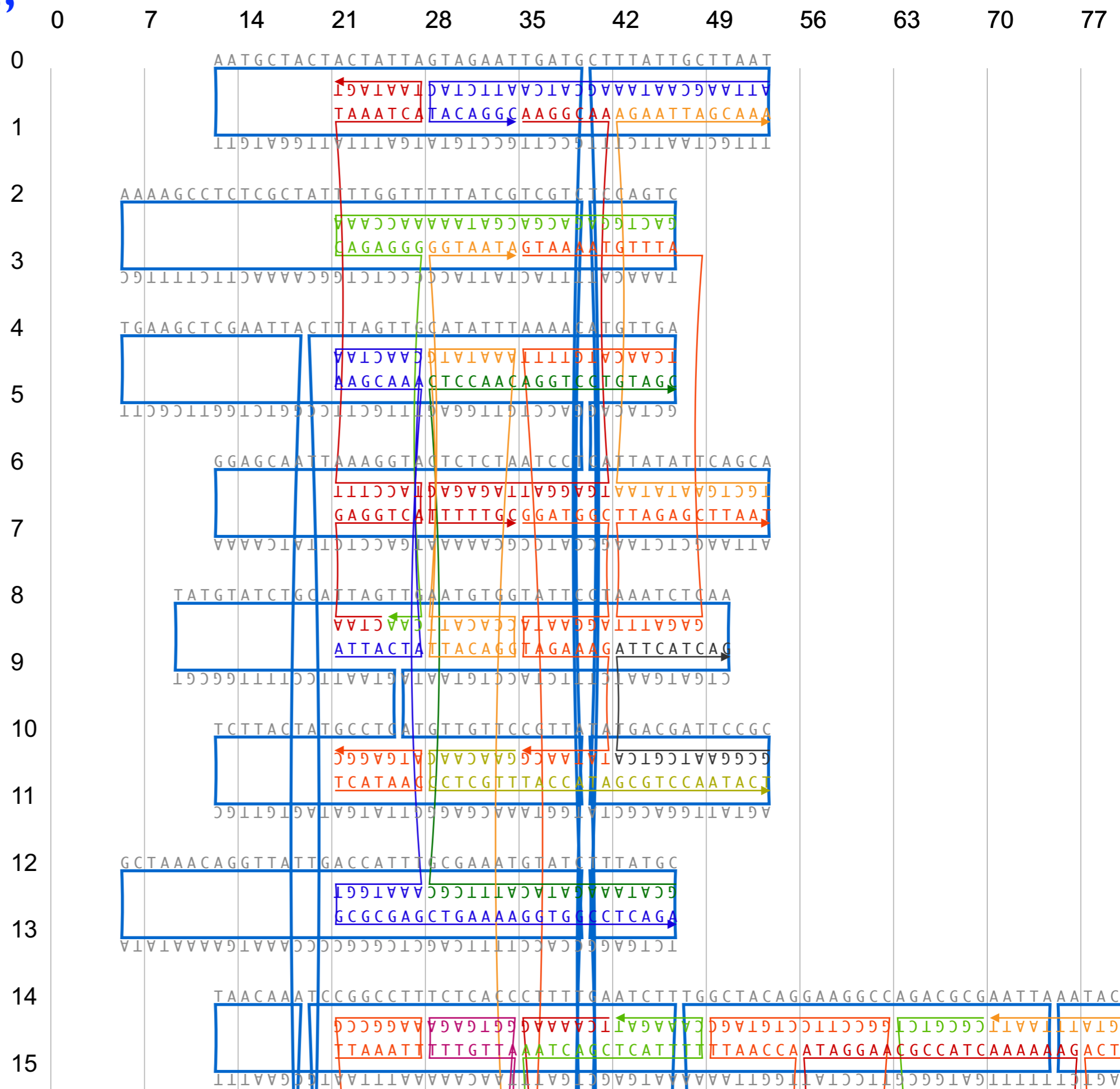
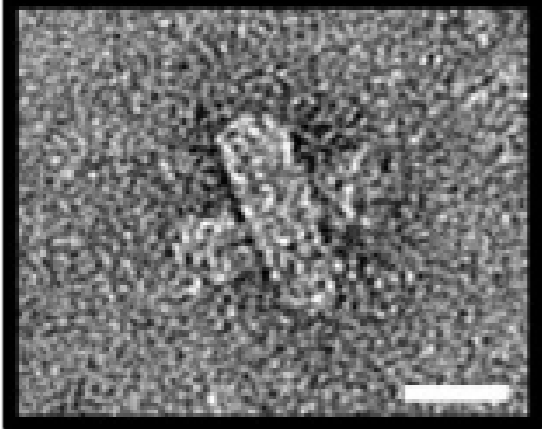
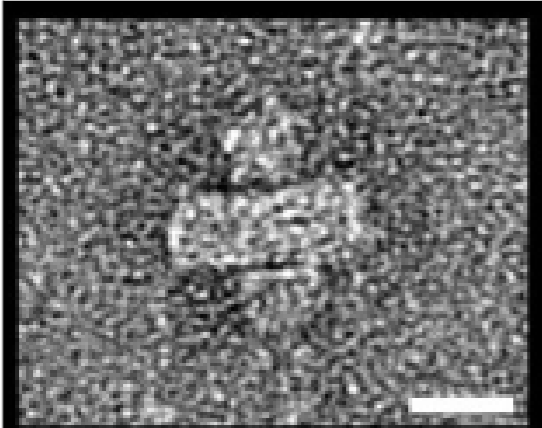
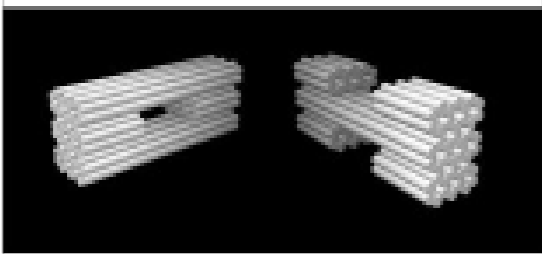
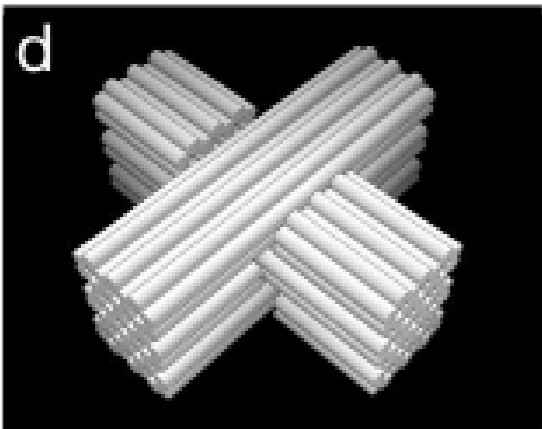

“Slotted Cross”

Björn Högberg

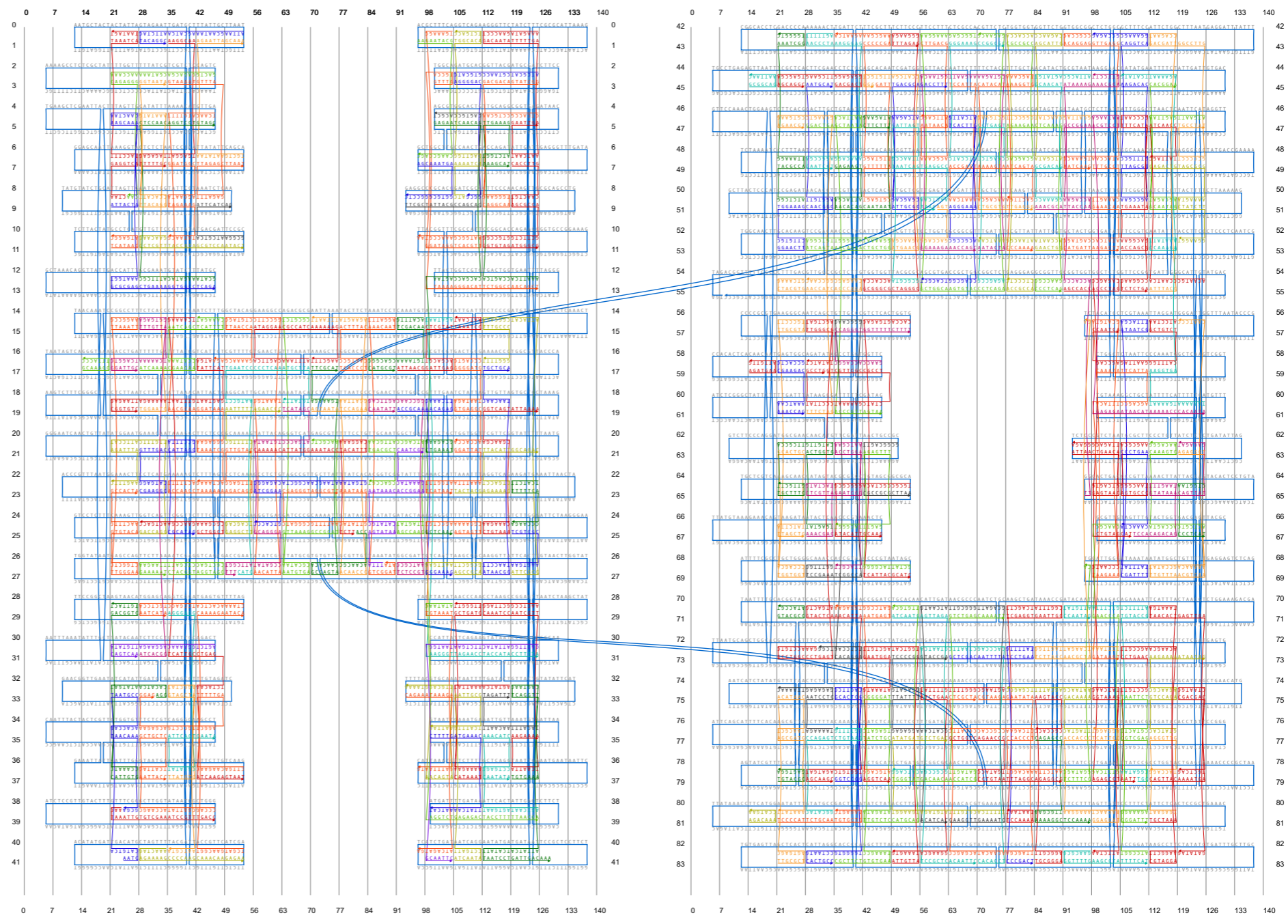
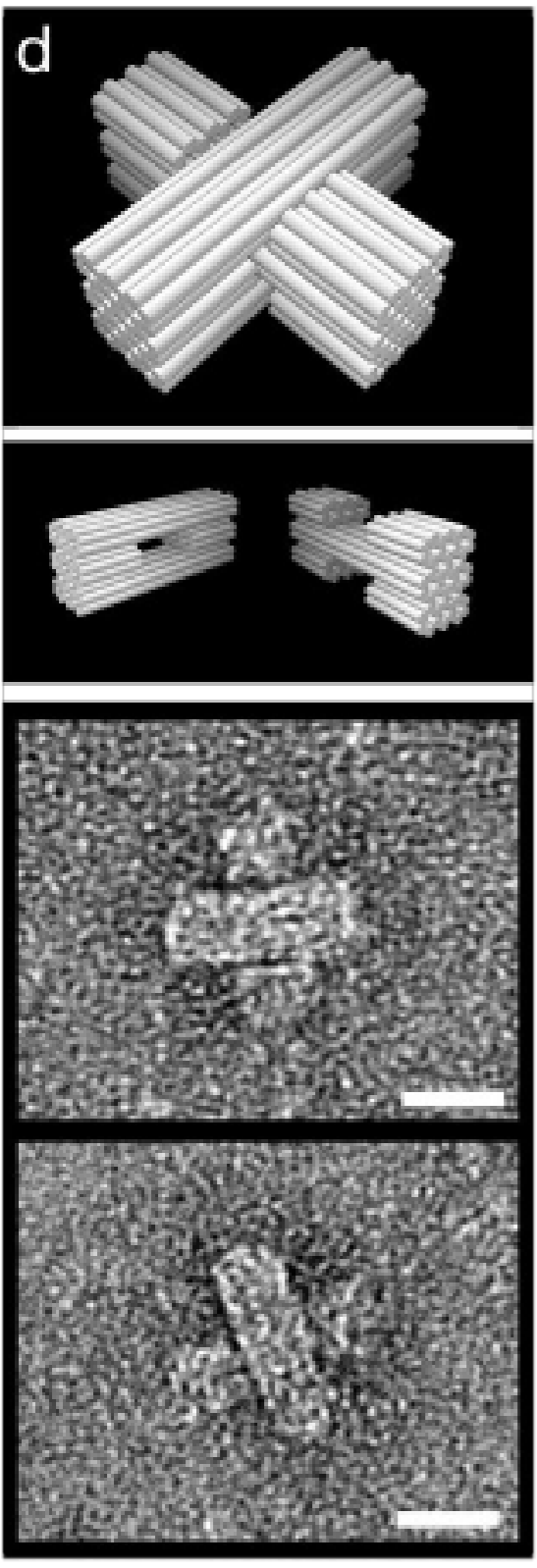

“Slotted Cross”

Björn Högberg

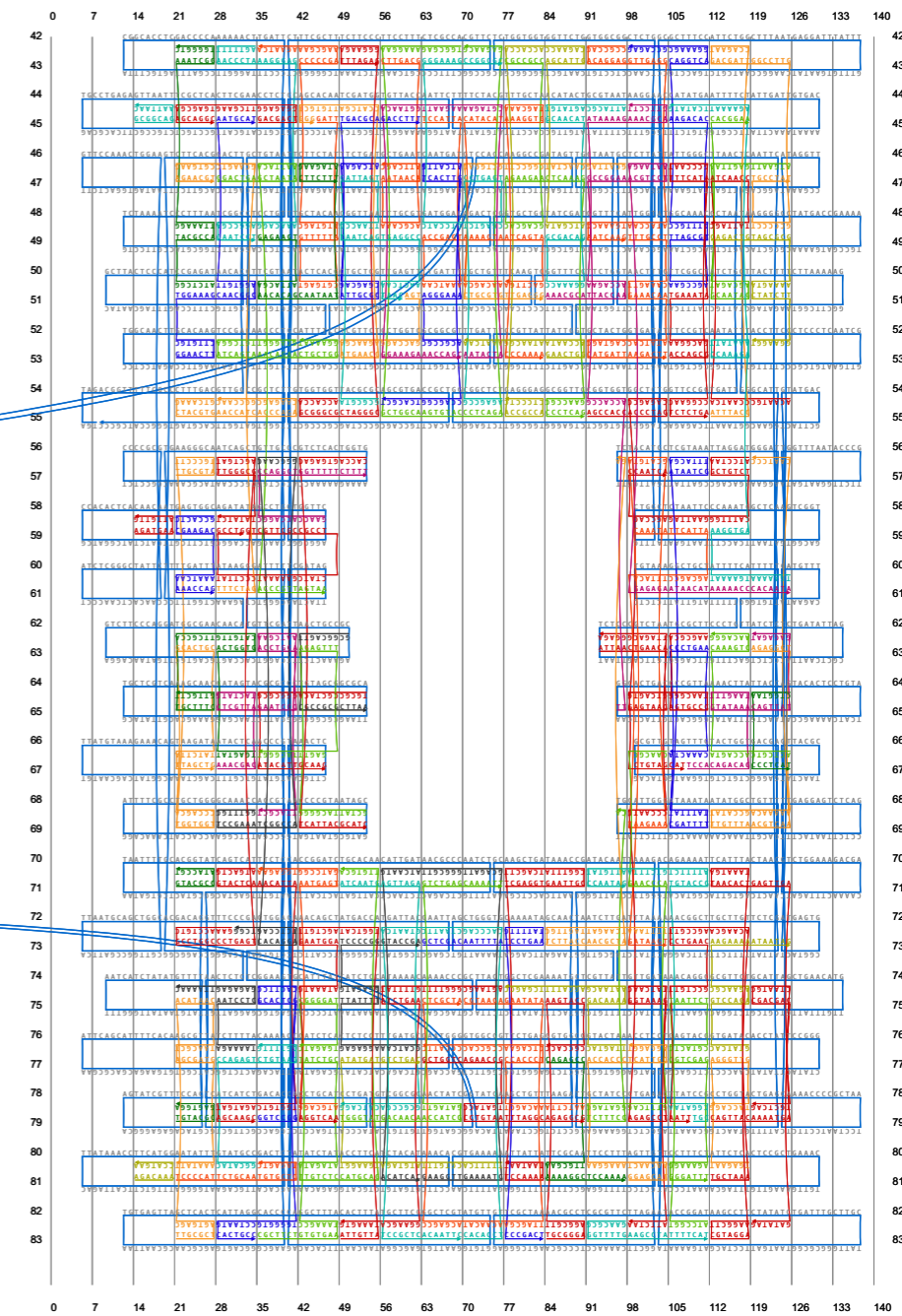
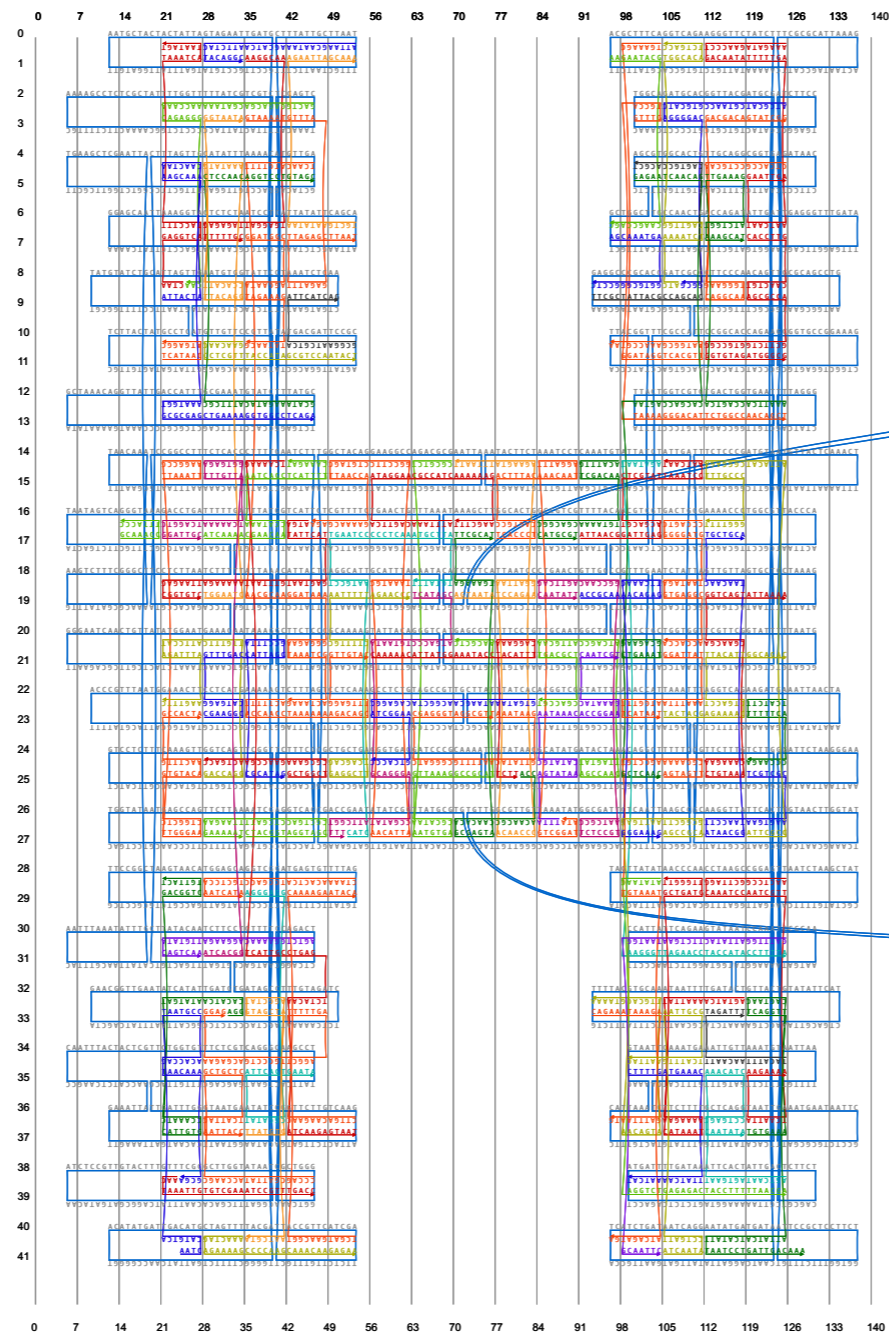
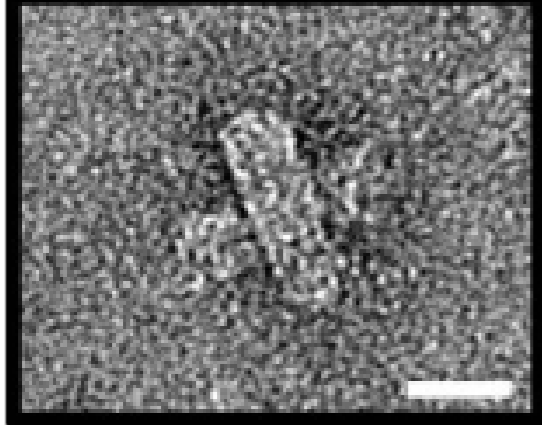
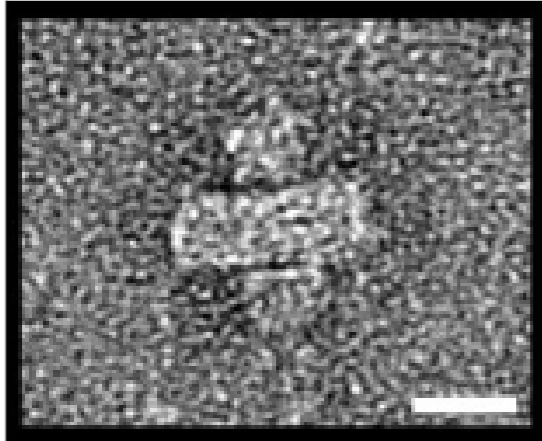
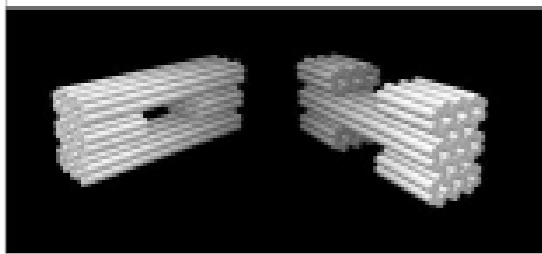
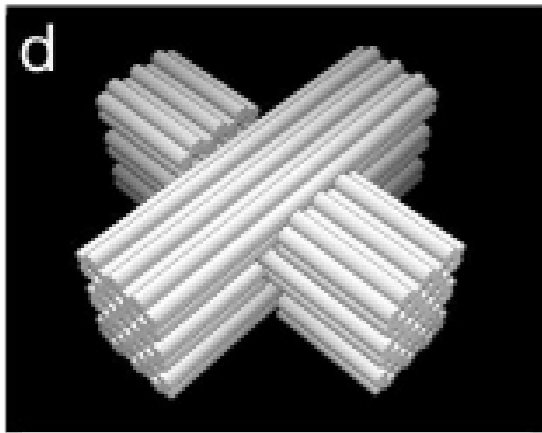

Design challenges

Steep learning curve

Ad hoc methods are tedious and error prone

New shapes can require days or weeks of effort



caDNAno

open-source software for design of
three-dimensional DNA origami

[Intro](#)[Tutorials](#)[Gallery](#)[Source](#)[Links](#)[Contact](#)

1. Download & Install



ADOBE AIR™

2. Get caDNAno



caDNAno

what is caDNAno?

caDNAno is software for design of three-dimensional [DNA origami](#) nanostructures. It was written with the goal of providing a simple and user-friendly interface to facilitate a process that can be complex and error-prone.

caDNAno features:

- No programming required
- Integrated 2D and 3D interfaces
- Visual cues to aid design process
- Export formats: [SVG](#), [X3D](#), [JSON](#)
- Platform independent
- Open source (MIT license)

Featured design



slotted cross

[view full gallery](#)

© Copyright 2009 Harvard University. All content available under [CC BY-SA](#) license.

[Shih Lab](#)

[Church Lab](#)

<http://cadnano.org/>

Douglas SM, Marblestone AM, Teerapittayanon S, Vazquez A, Church GM, Shih WM. *Nucleic Acids Res.* In press, 2009.

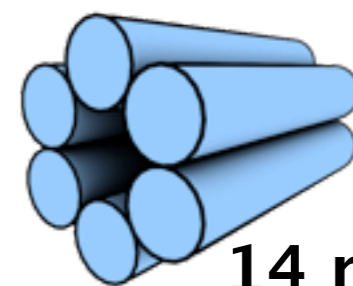
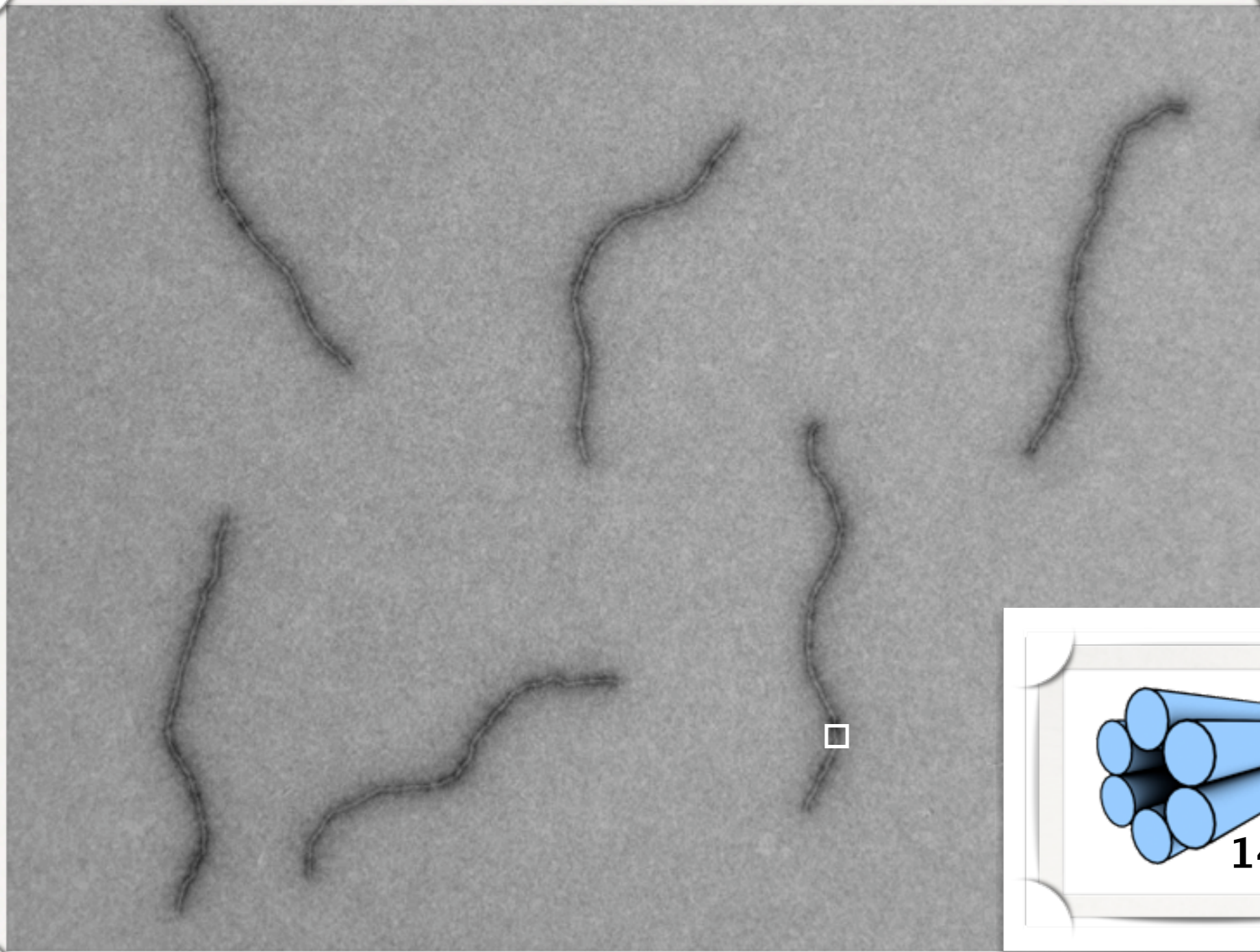

14 nm

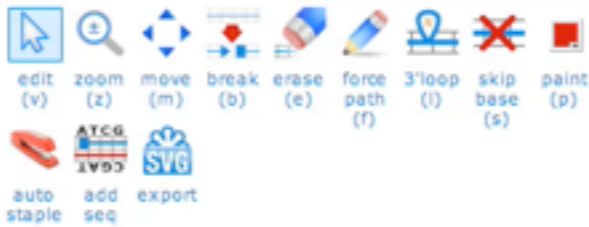
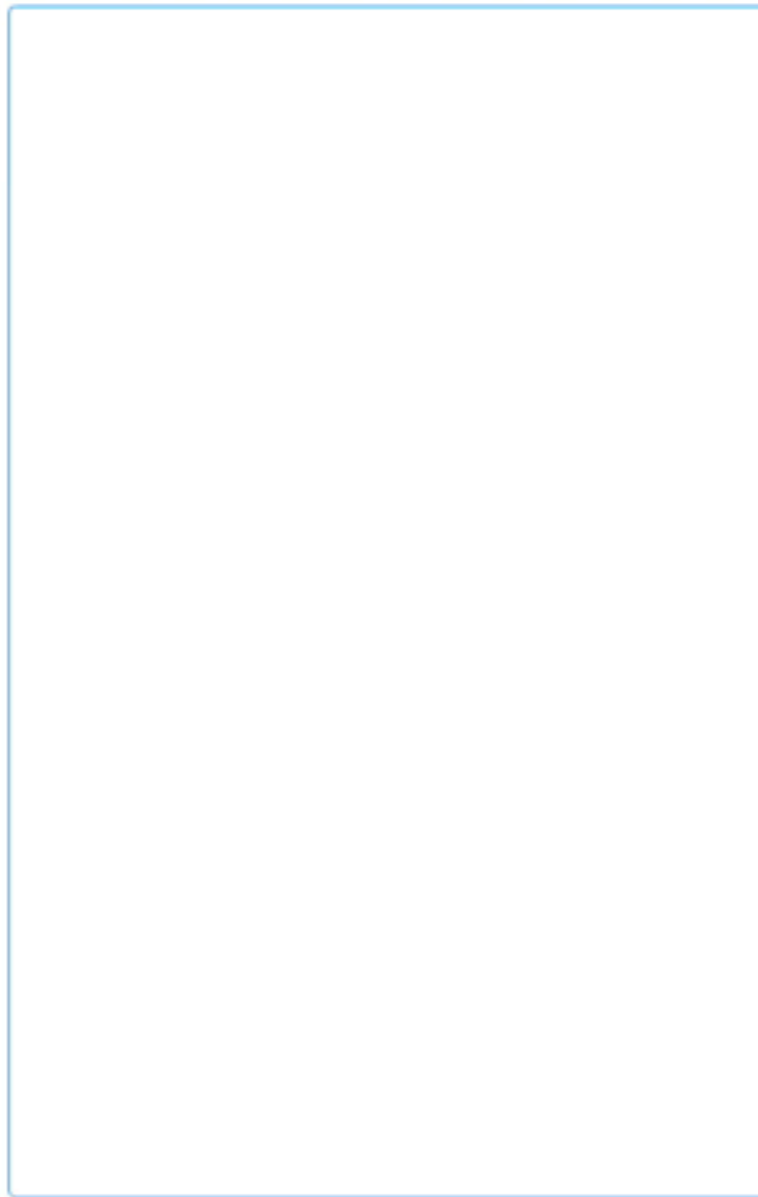
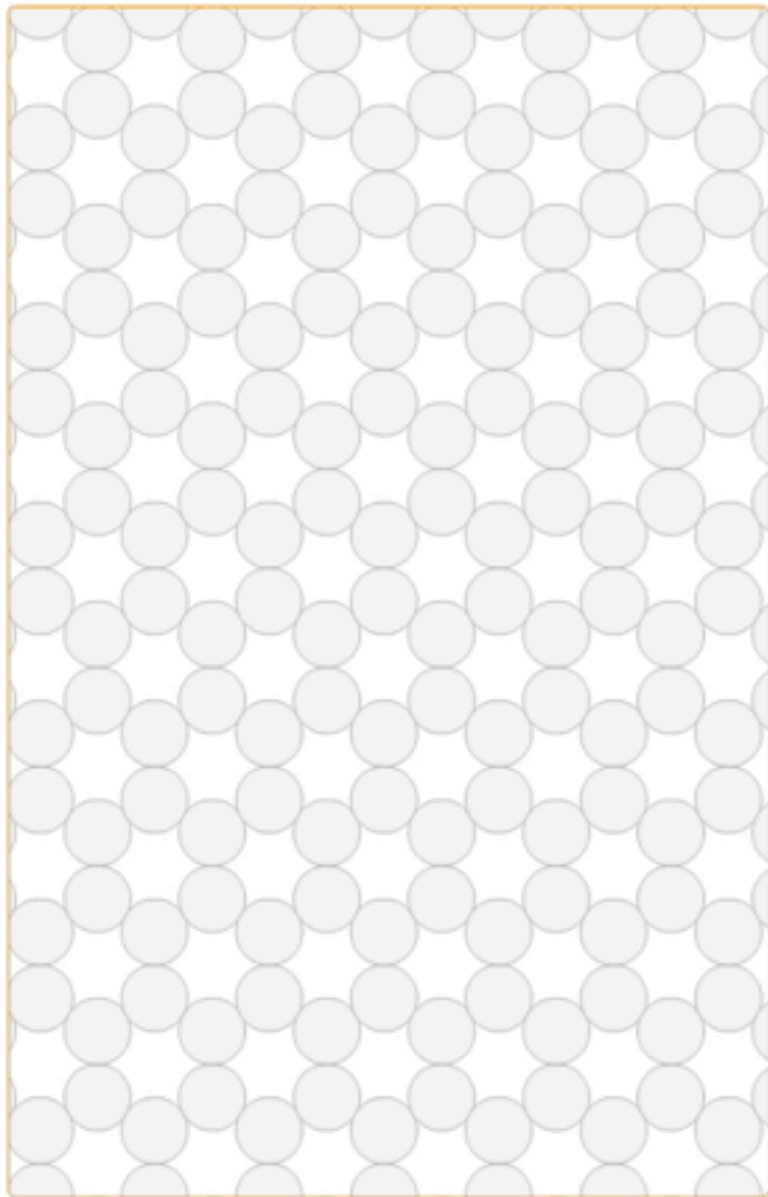

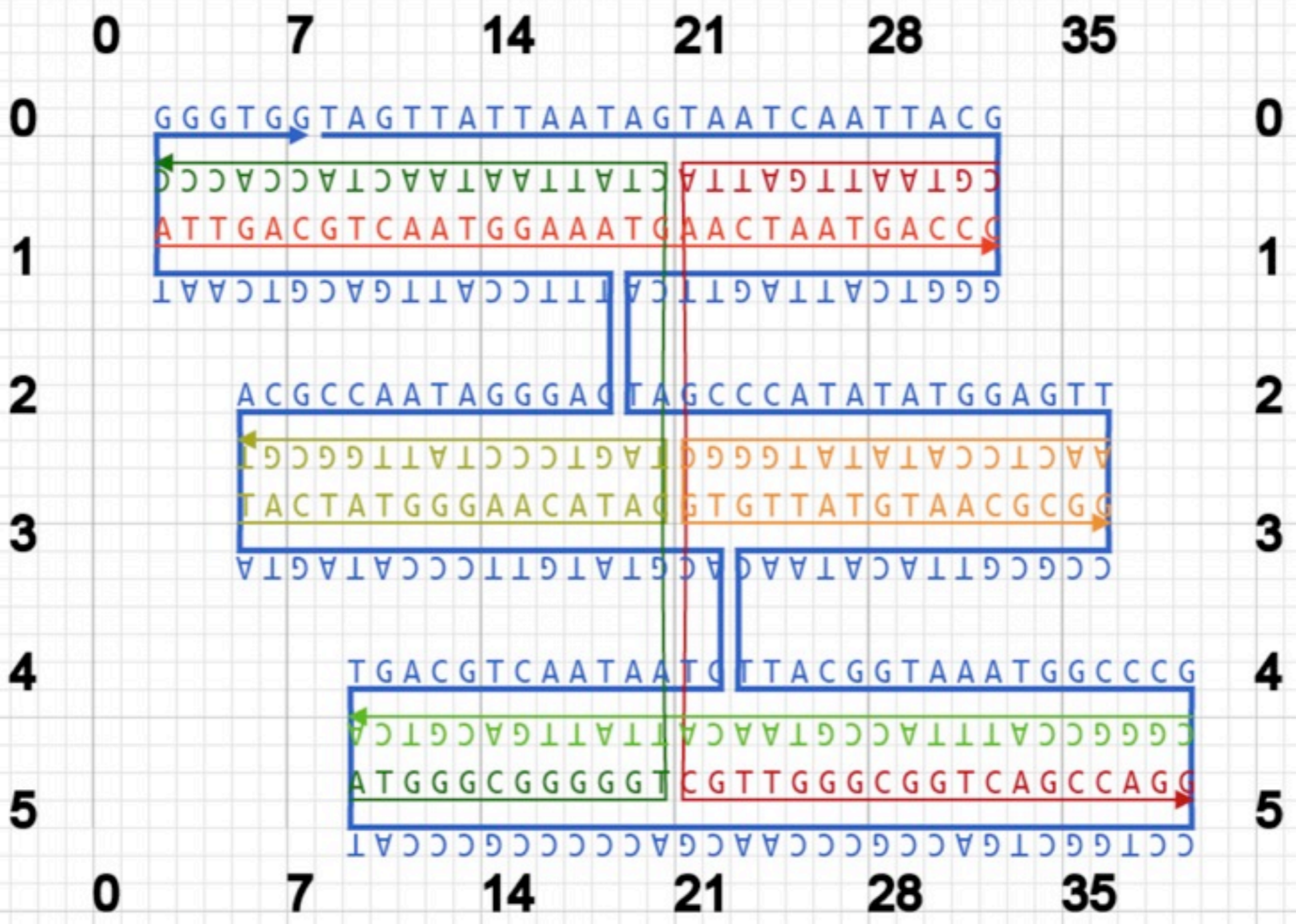

Exploring shape dependence of DNA-particle cellular uptake



Franziska Graf

Katrina Galkina



caDNAno

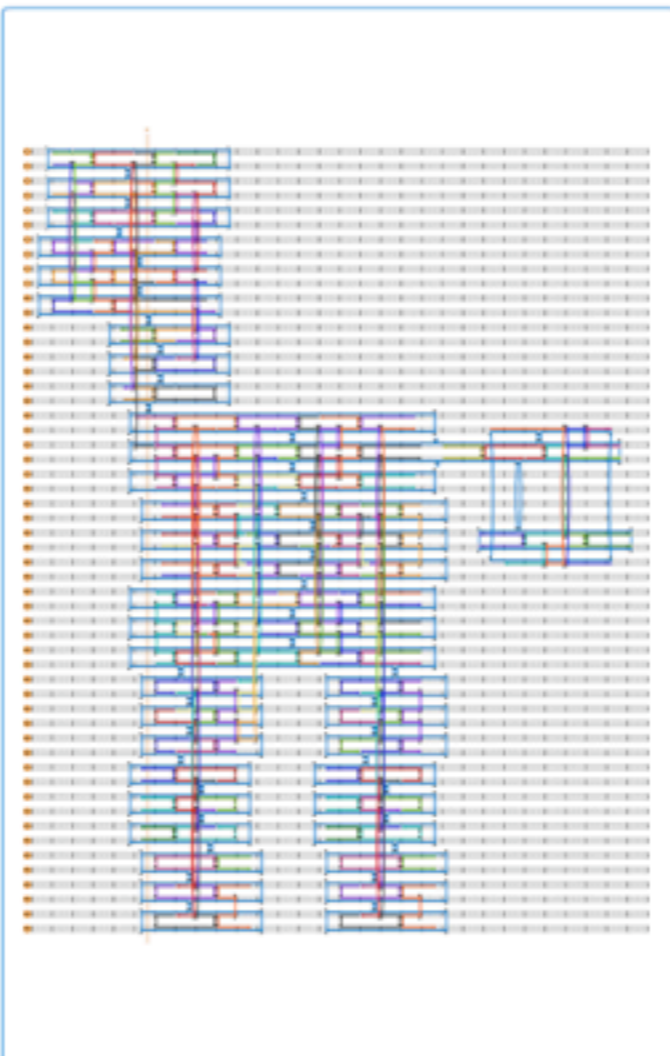
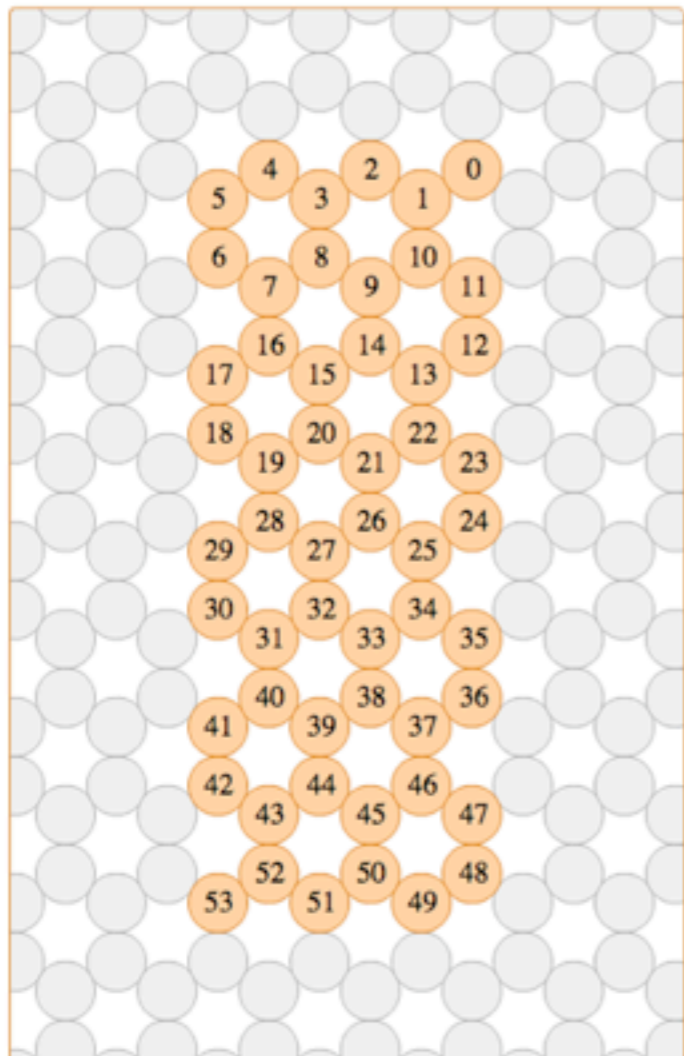

edit zoom move first prev next last

edit (v) zoom (z) move (m) break (b) erase (e) force path (f) 3'loop (l) skip base (s) paint (p)

auto staple add seq export

zoom move export

open save save as use server

DOCK

loaded: trojan.v1.order
22:45:13

TEM

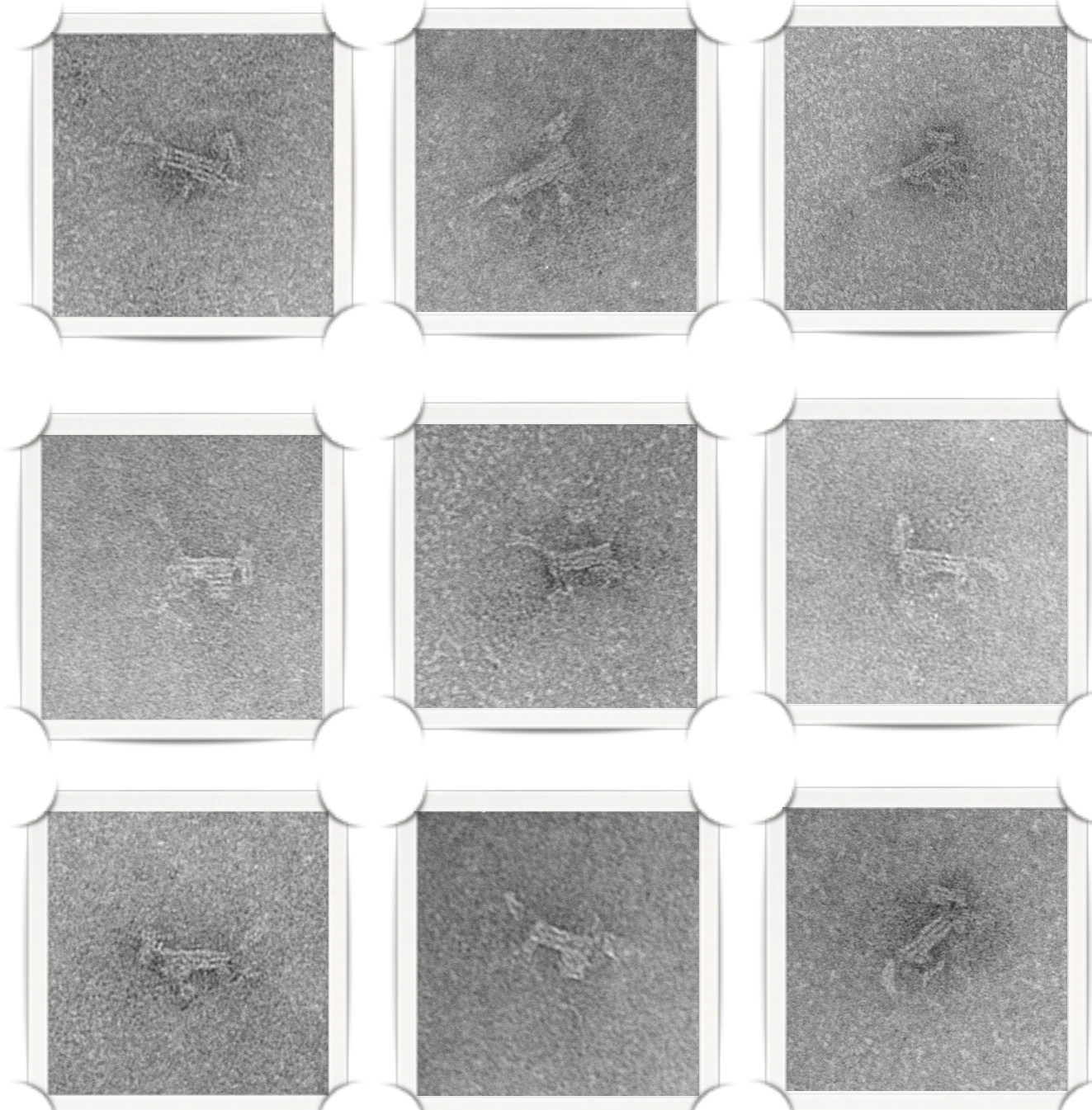

100 nm

TEM

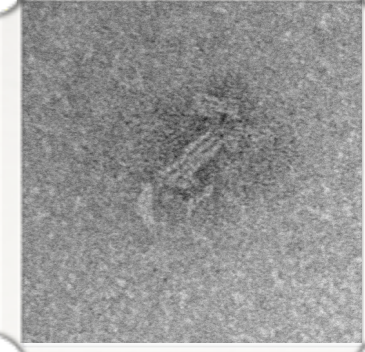
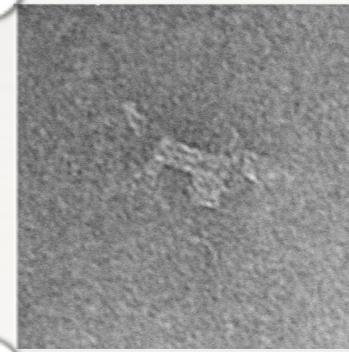
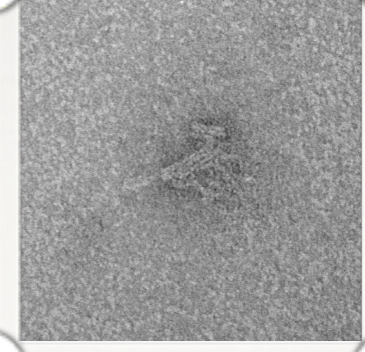
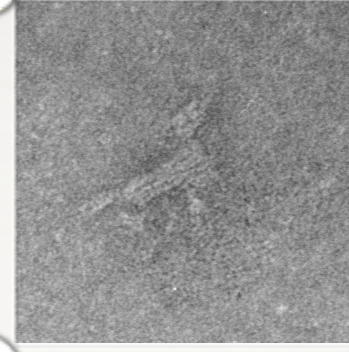
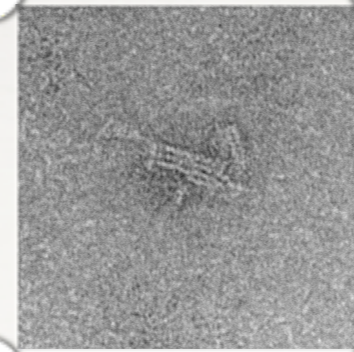
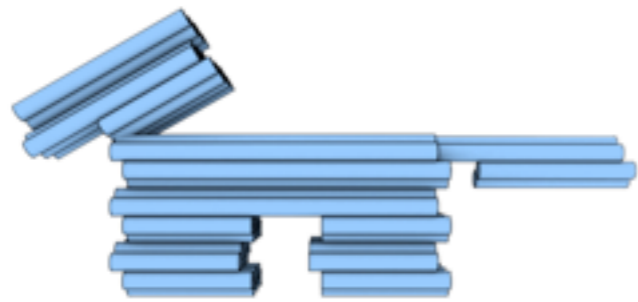

100 nm

Closeups

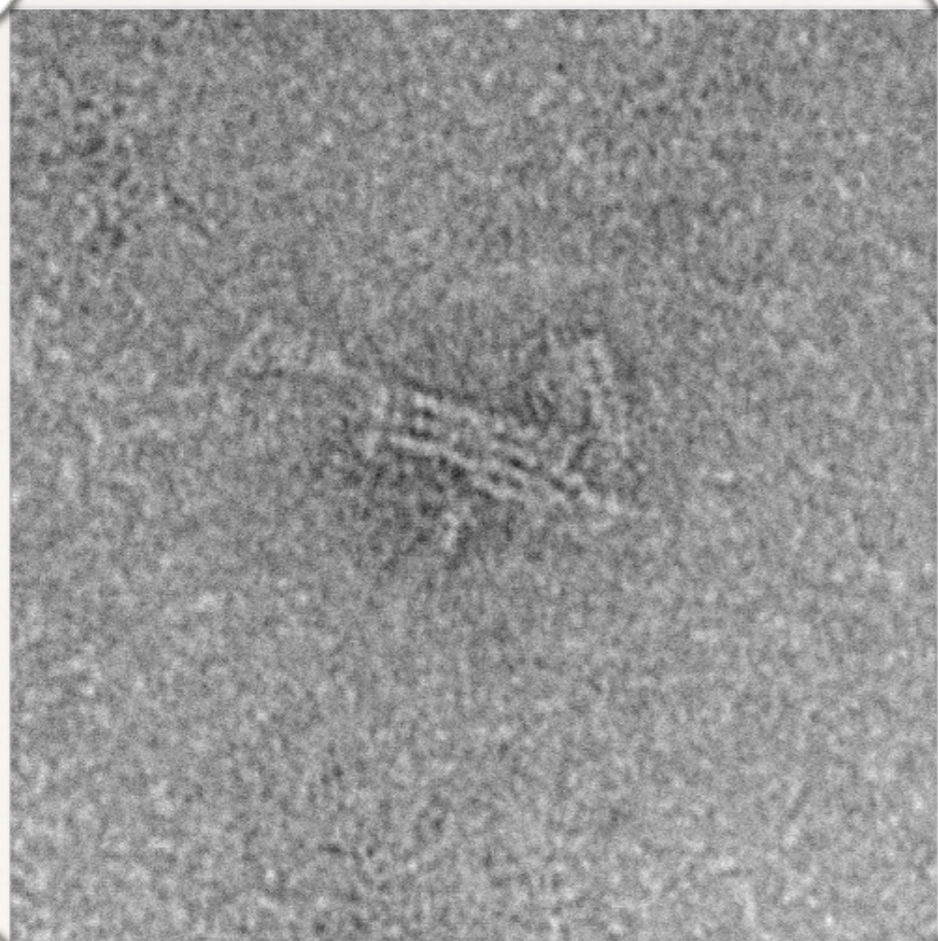

100 nm



Dietz H, Douglas SM, Shih WM. **Science** 325, 725–730, 2009.



**6-tooth
gear**

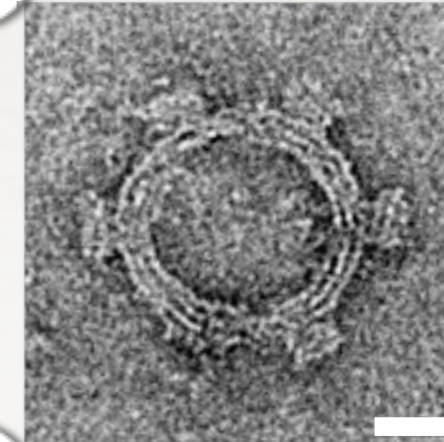
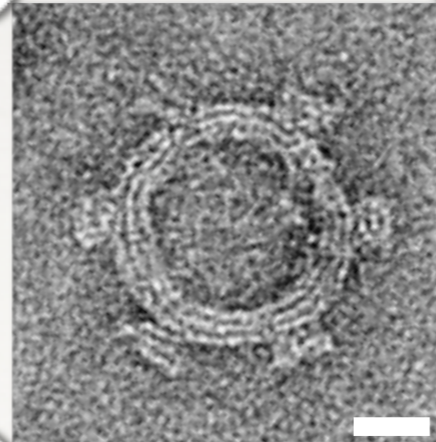

**12-tooth
gear**

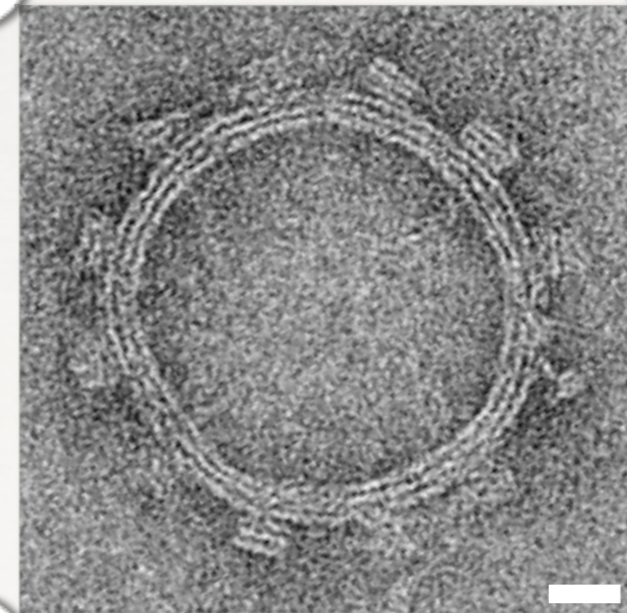
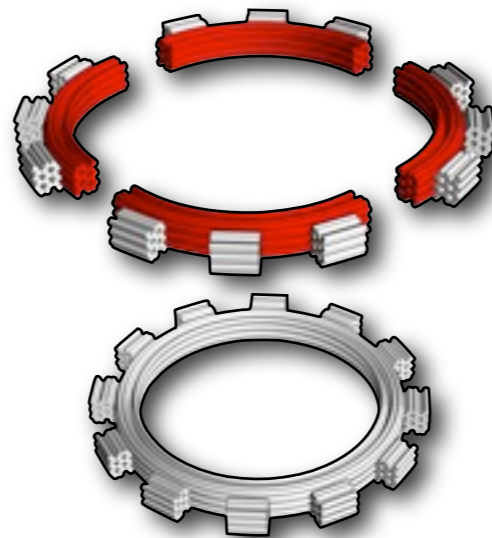

Conclusions

We can self-assemble arbitrary 3D-origami DNA nanostructures.

Precise control over self-assembly of 3D DNA nanostructures will be useful.



Support

NIH New Innovator Award
DFCI Barr Award in Innovative
Basic Cancer Research
Wyss Institute for Biologically
Inspired Engineering

Conclusions

We can self-assemble
arbitrary 3D-origami
DNA nanostructures.

Precise control over
self-assembly of
3D DNA nanostructures
will be useful.

Support

NIH New Innovator Award
DFCI Barr Award in Innovative
Basic Cancer Research
Wyss Institute for Biologically
Inspired Engineering