

Reliable Behavior or Not?

What is Happening Inside Tiny Organisms?

Drew Endy

Departments of Biological Engineering

MIT → Stanford

ASC @ MIT Media Lab

17 April 2008

A**B****C**

Figure 1: Confocal microscope images of a fruit fly embryo, stained with fluorescent antibodies to three different gene products (Bicoid, Hunchback and Even-skipped)



Establishment of developmental precision and proportions in the early *Drosophila* embryo

Bahram Houchmandzadeh*†, Eric Wieschaus* & Stanislas Leibler*‡§

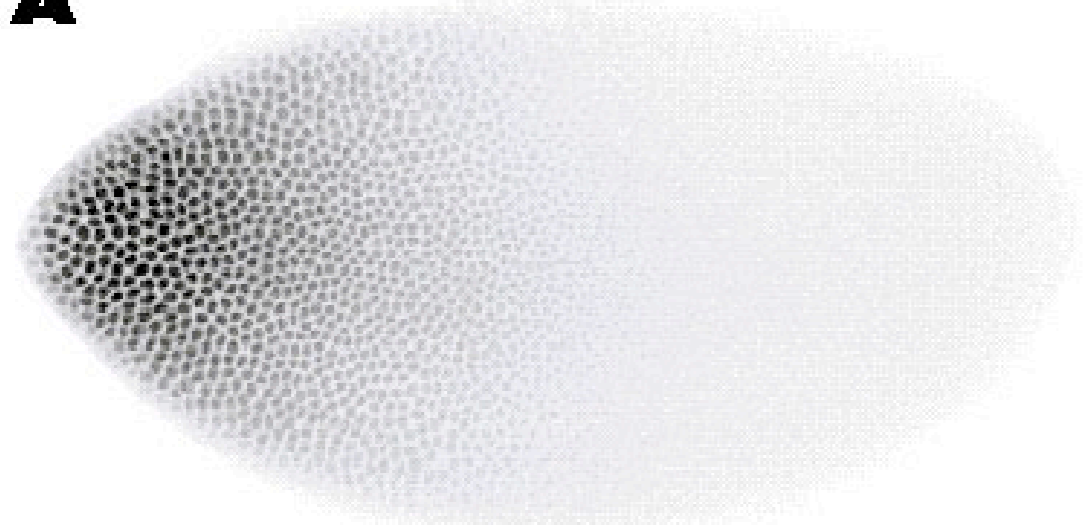
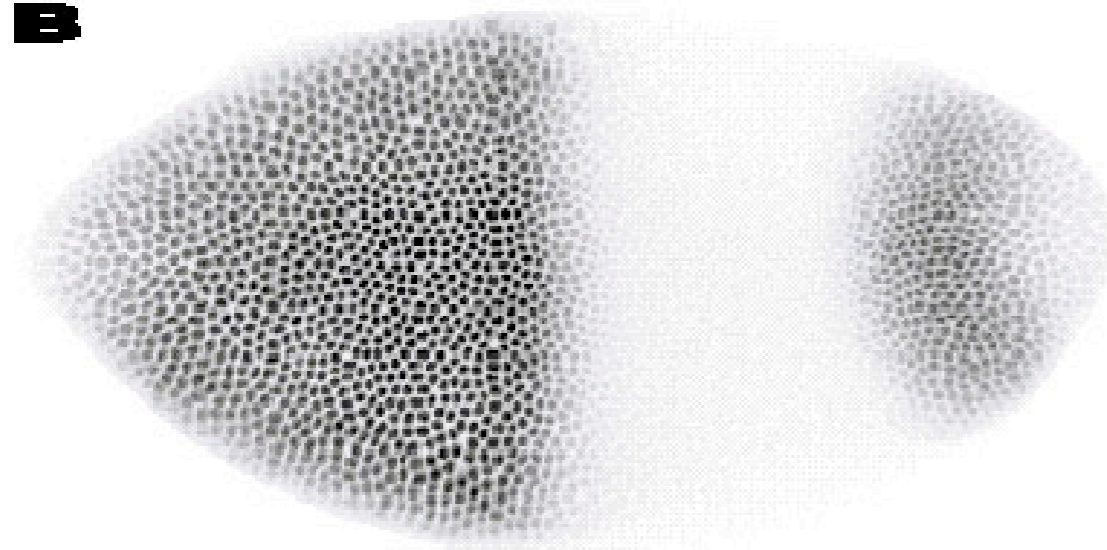
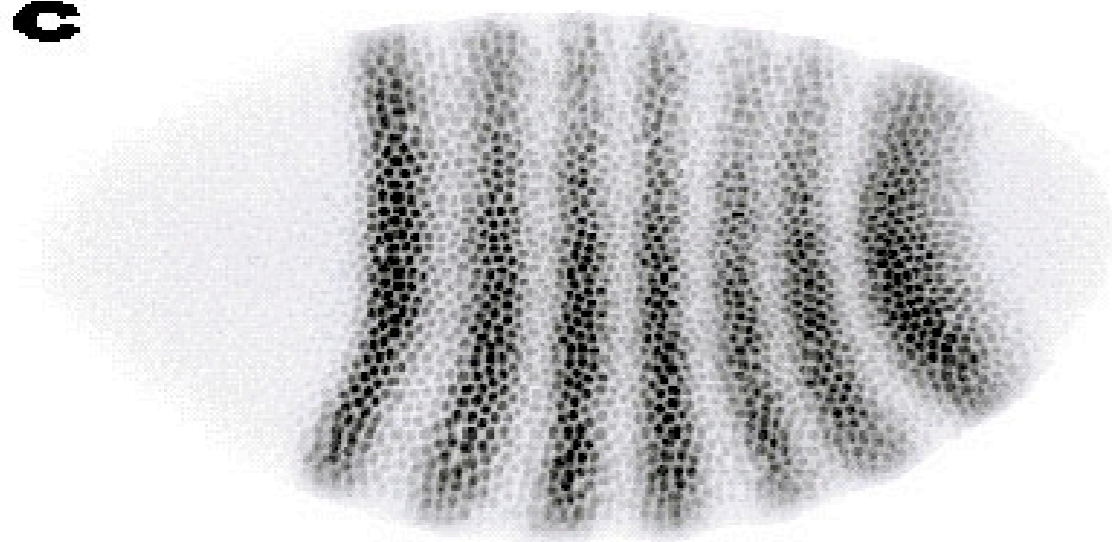
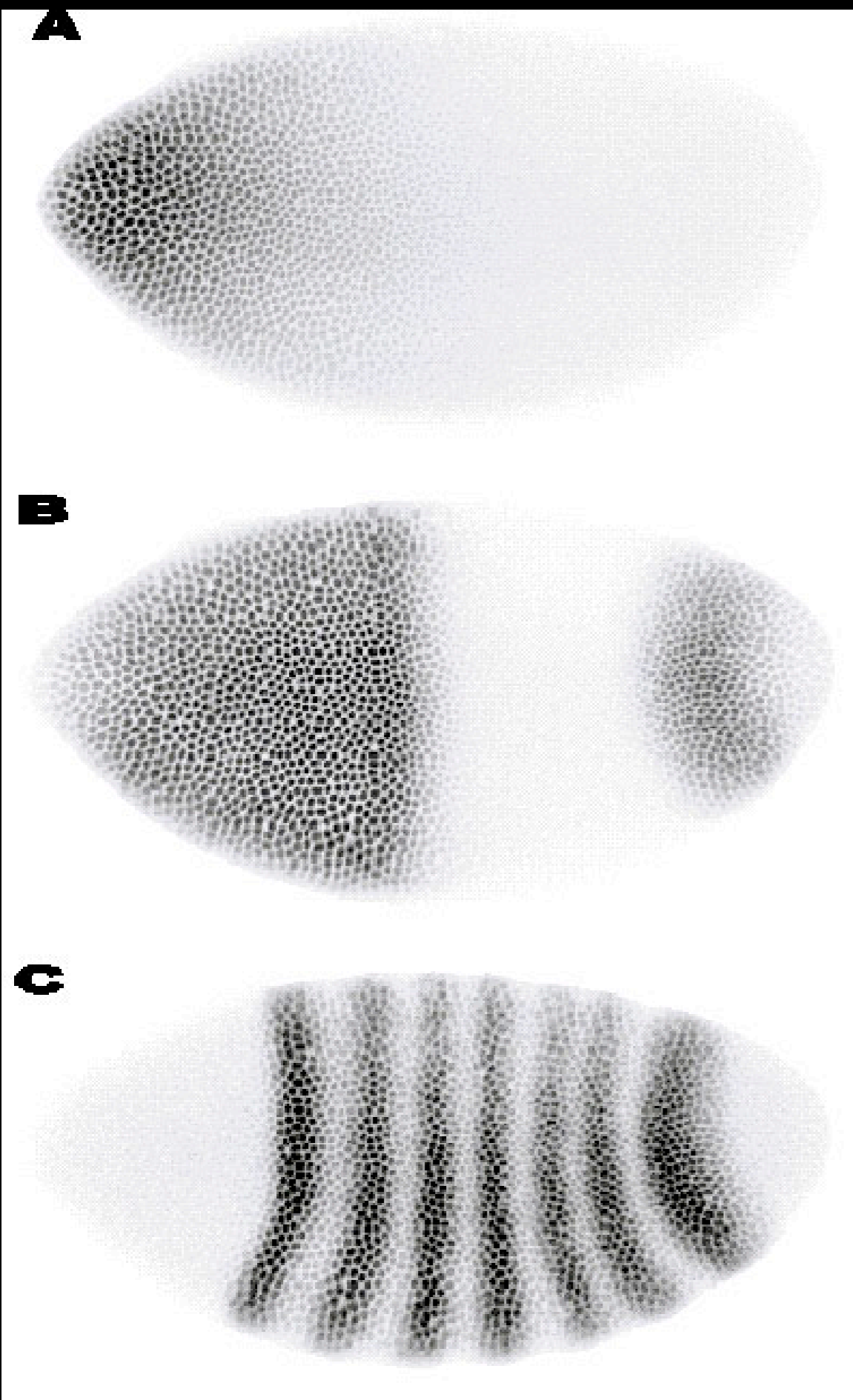
* Howard Hughes Medical Institute, Department of Molecular Biology, Princeton University, Princeton, New Jersey 08544, USA

† CNRS, Laboratoire de Spectrometrie Physique, BP87, 38402, St-Martin D'Herès Cedex, France

‡ Department of Physics, Princeton University, Princeton, New Jersey 08544, USA

During embryonic development, orderly patterns of gene expression eventually assign each cell in the embryo its particular fate. For the anteroposterior axis of the *Drosophila* embryo, the first step in this process depends on a spatial gradient of the maternal morphogen Bicoid (Bcd). Positional information of this gradient is transmitted to downstream gap genes, each occupying a well defined spatial domain¹⁻⁴. We determined the precision of the initial process by comparing expression domains in different embryos. Here we show that the Bcd gradient displays a high embryo-to-embryo variability, but that this noise in the positional information is strongly decreased ('filtered') at the level of *hunchback* (*hb*) gene expression. In contrast to the Bcd gradient, the *hb* expression pattern already includes the information about the scale of the embryo. We show that genes known to interact directly with Hb are not responsible for its spatial precision, but that the maternal gene *staufer* may be crucial.

Figure 1: Confocal microscope images of a fruit fly embryo, stained with fluorescent antibodies to three different gene products (Bicoid, Hunchback and Even-skipped)

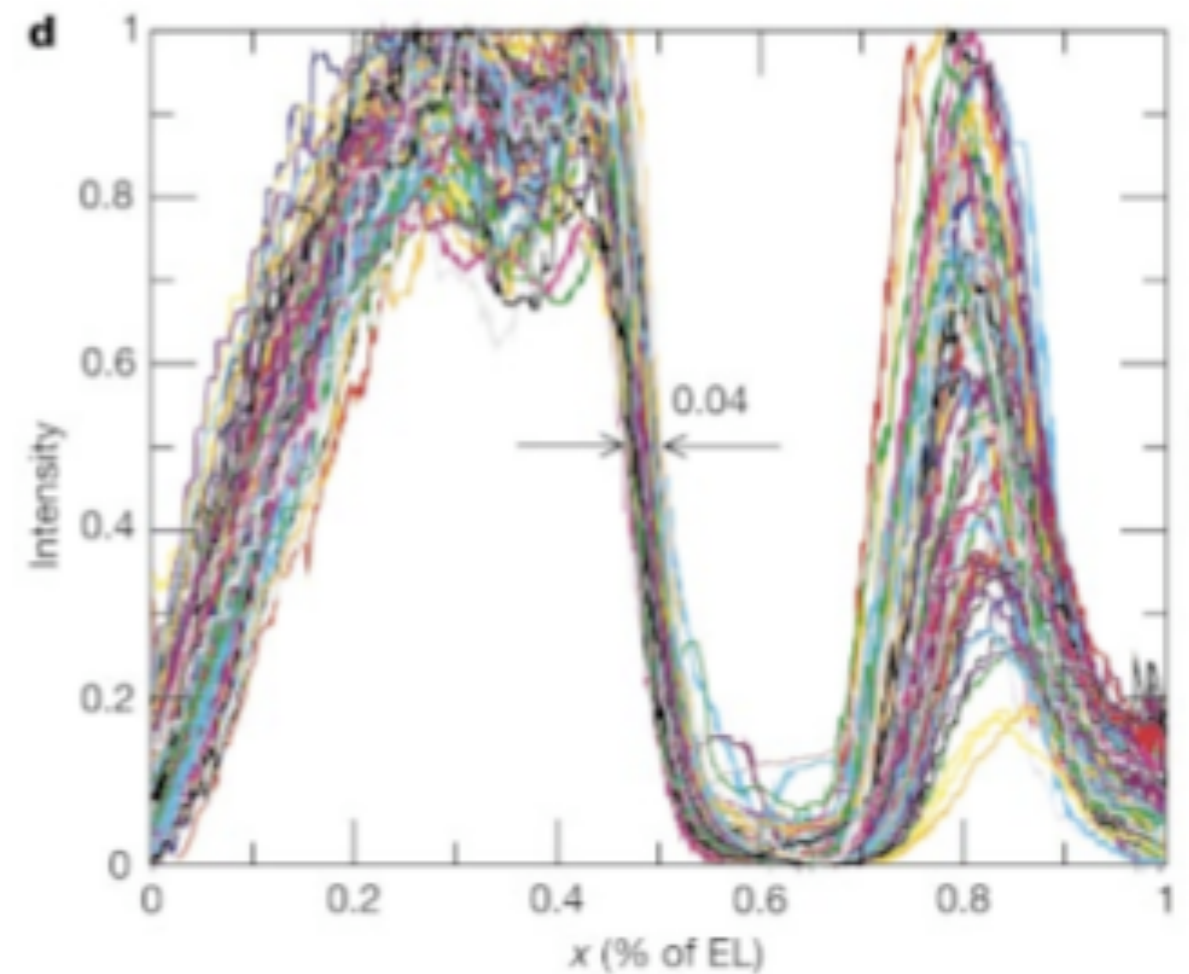
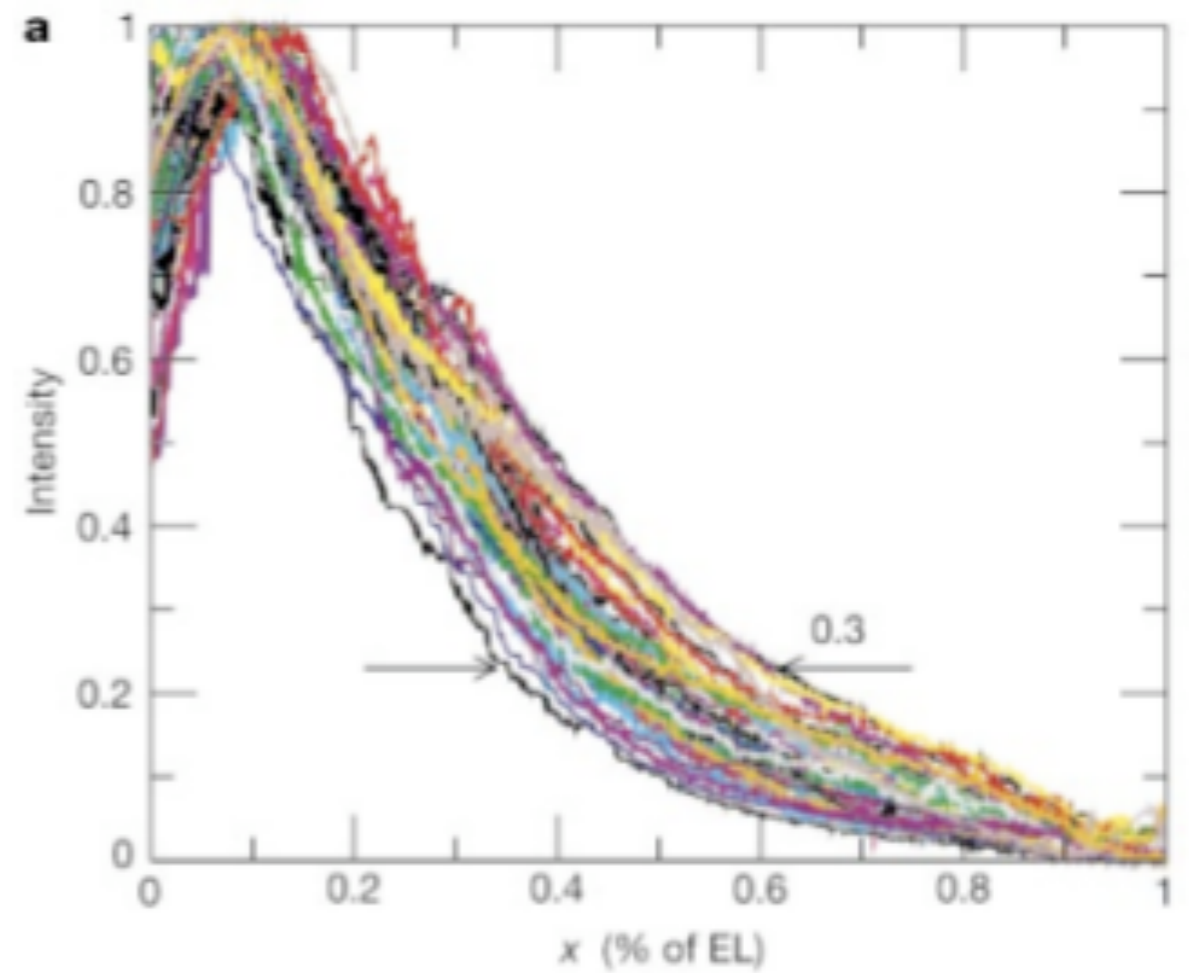
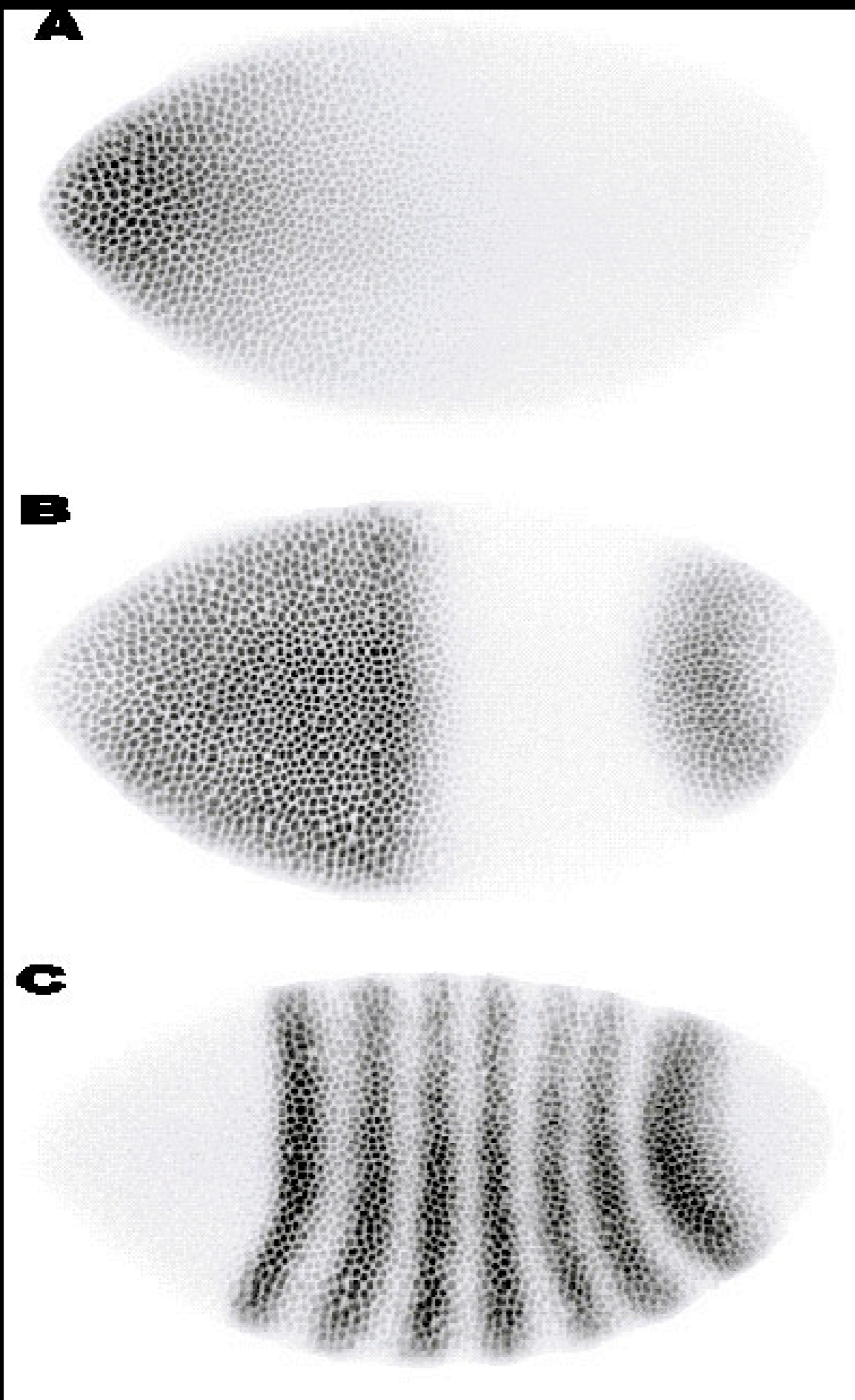

Figure 1: Confocal microscope images of a fruit fly embryo, stained with fluorescent antibodies to three different gene products (Bicoid, Hunchback and Even-skipped)

Stochastic Kinetic Analysis of Developmental Pathway Bifurcation in Phage λ -Infected *Escherichia coli* Cells

Adam Arkin,^{*,1} John Ross[†] and Harley H. McAdams^{*}

^{*}*Department of Developmental Biology and* [†]*Department of Chemistry, Stanford University, Stanford, California 94305*

Manuscript received March 5, 1998

Accepted for publication April 30, 1998

ABSTRACT

Fluctuations in rates of gene expression can produce highly erratic time patterns of protein production in individual cells and wide diversity in instantaneous protein concentrations across cell populations. When two independently produced regulatory proteins acting at low cellular concentrations competitively control a switch point in a pathway, stochastic variations in their concentrations can produce probabilistic pathway selection, so that an initially homogeneous cell population partitions into distinct phenotypic subpopulations. Many pathogenic organisms, for example, use this mechanism to randomly switch surface features to evade host responses. This coupling between molecular-level fluctuations and macroscopic phenotype selection is analyzed using the phage λ lysis-lysogeny decision circuit as a model system. The fraction of infected cells selecting the lysogenic pathway at different phage:cell ratios, predicted using a molecular-level stochastic kinetic model of the genetic regulatory circuit, is consistent with experimental observations. The kinetic model of the decision circuit uses the stochastic formulation of chemical kinetics, stochastic mechanisms of gene expression, and a statistical-thermodynamic model of promoter regulation. Conventional deterministic kinetics cannot be used to predict statistics of regulatory systems that produce probabilistic outcomes. Rather, a stochastic kinetic analysis must be used to predict statistics of regulatory outcomes for such stochastically regulated systems.

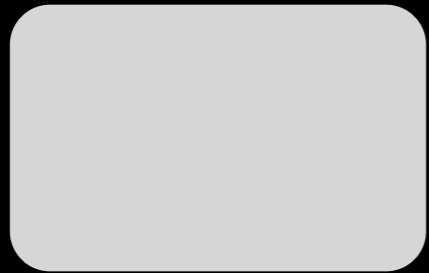

François St-Pierre

λ

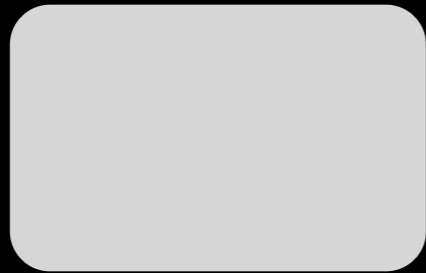

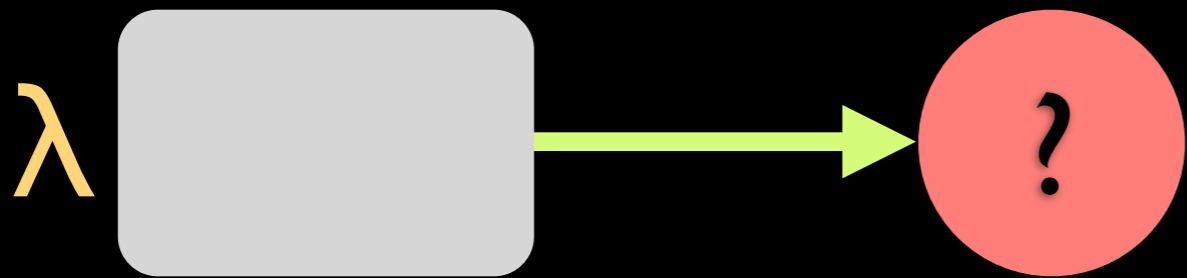

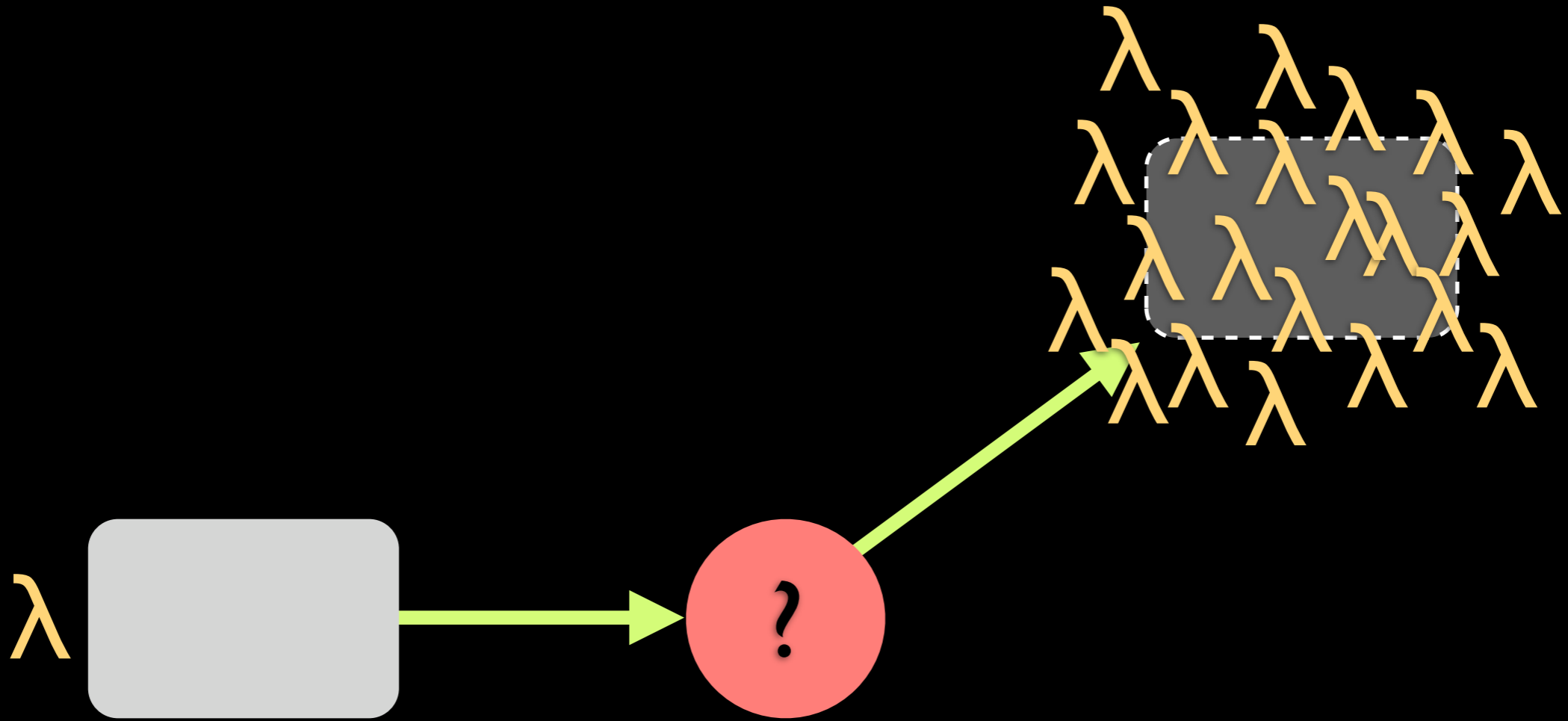

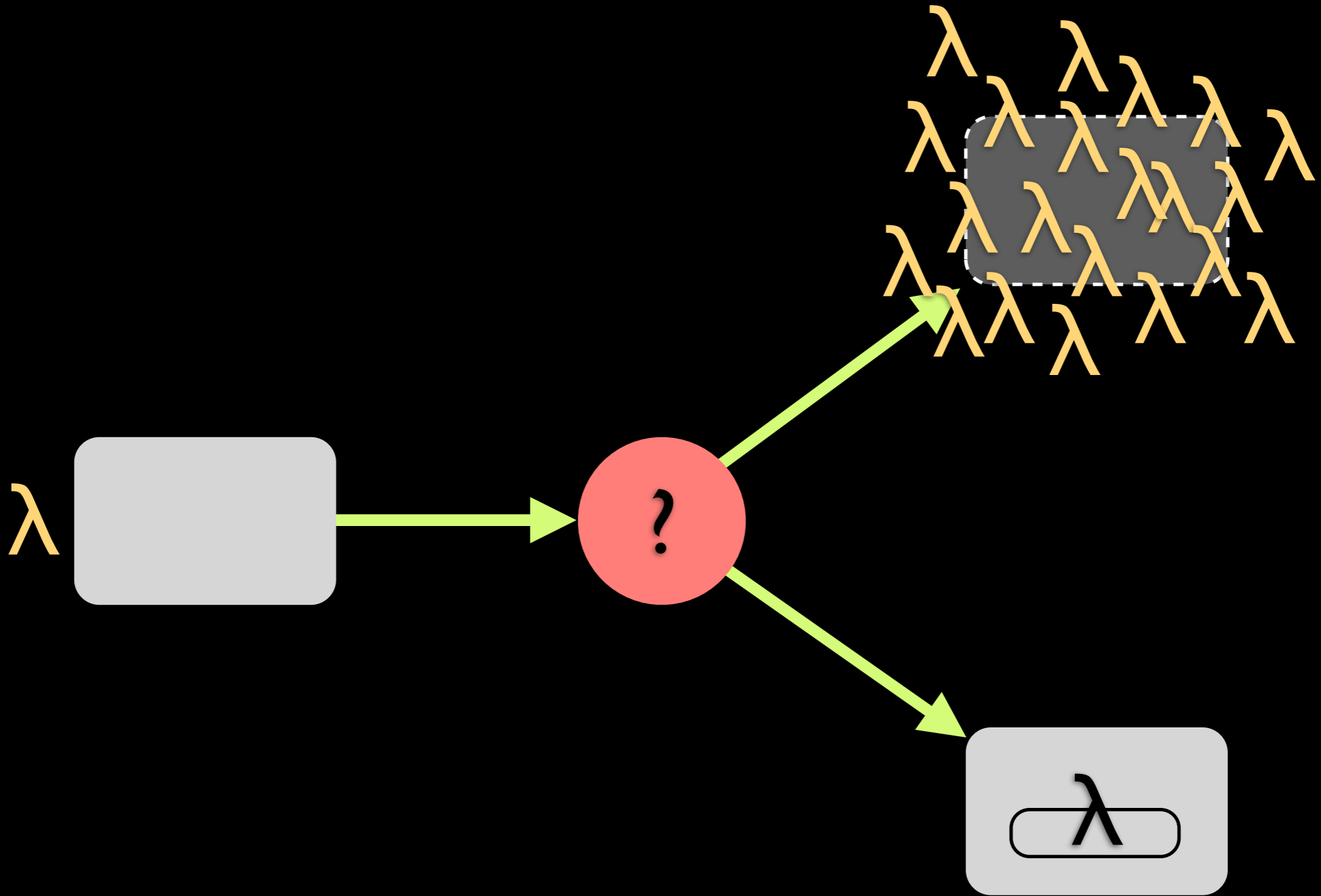



François St-Pierre

λ

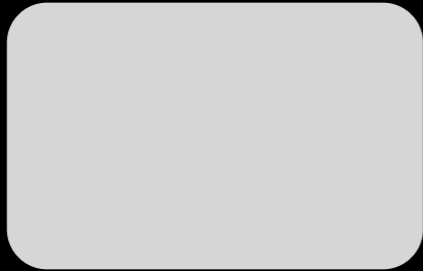

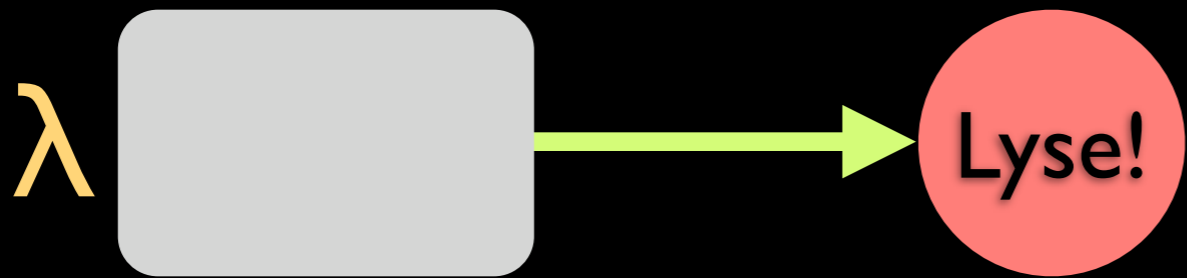

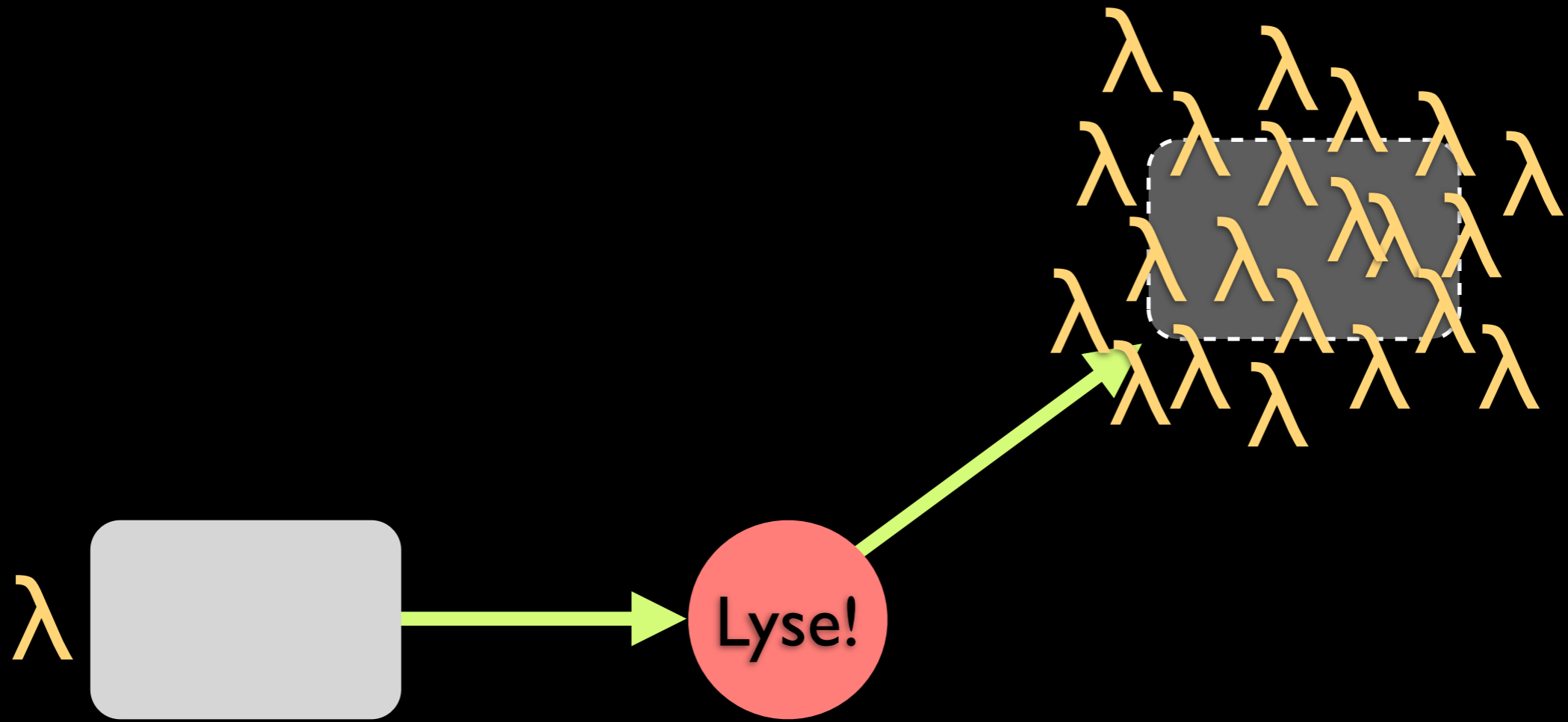

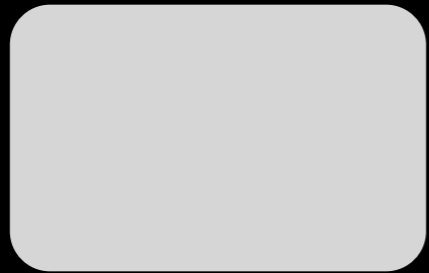

François St-Pierre

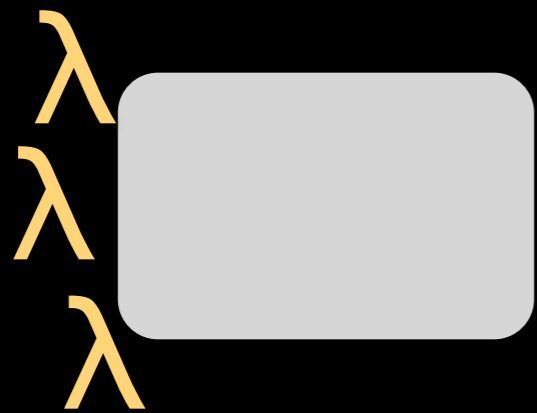

François St-Pierre

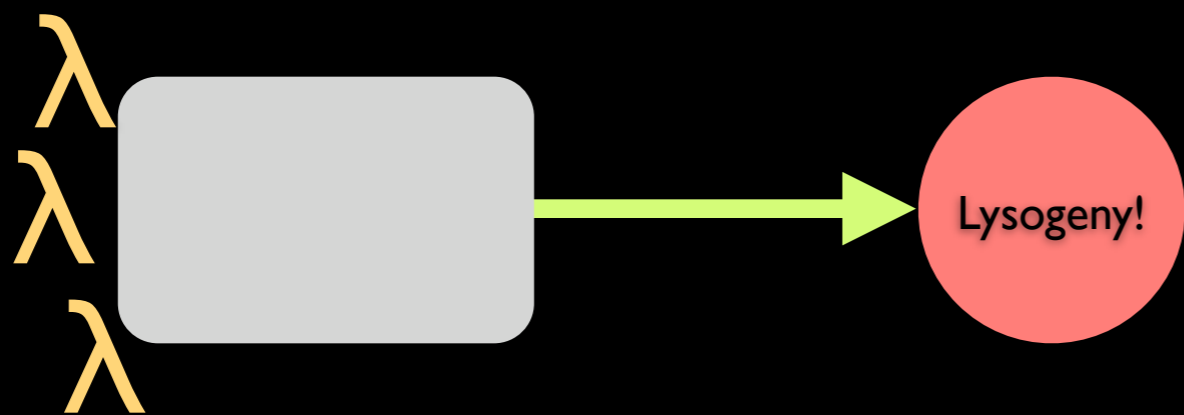

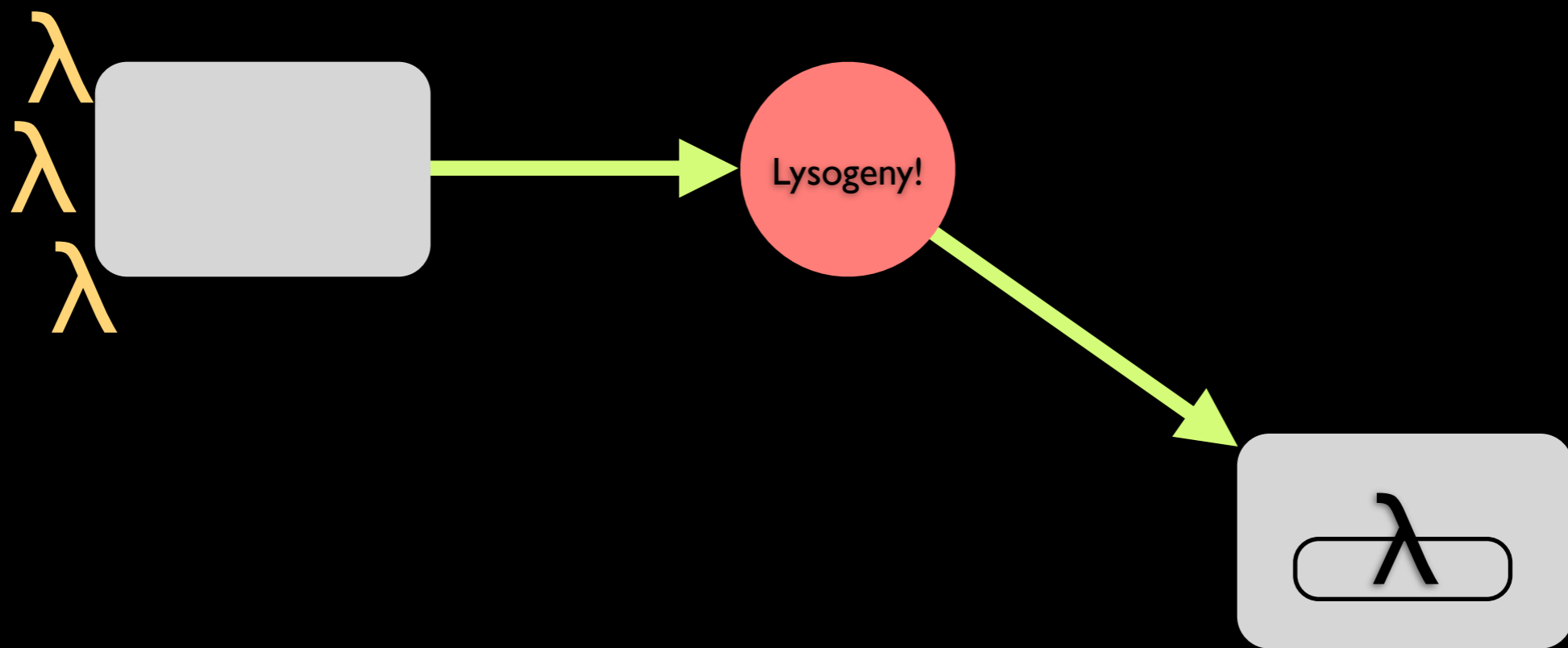

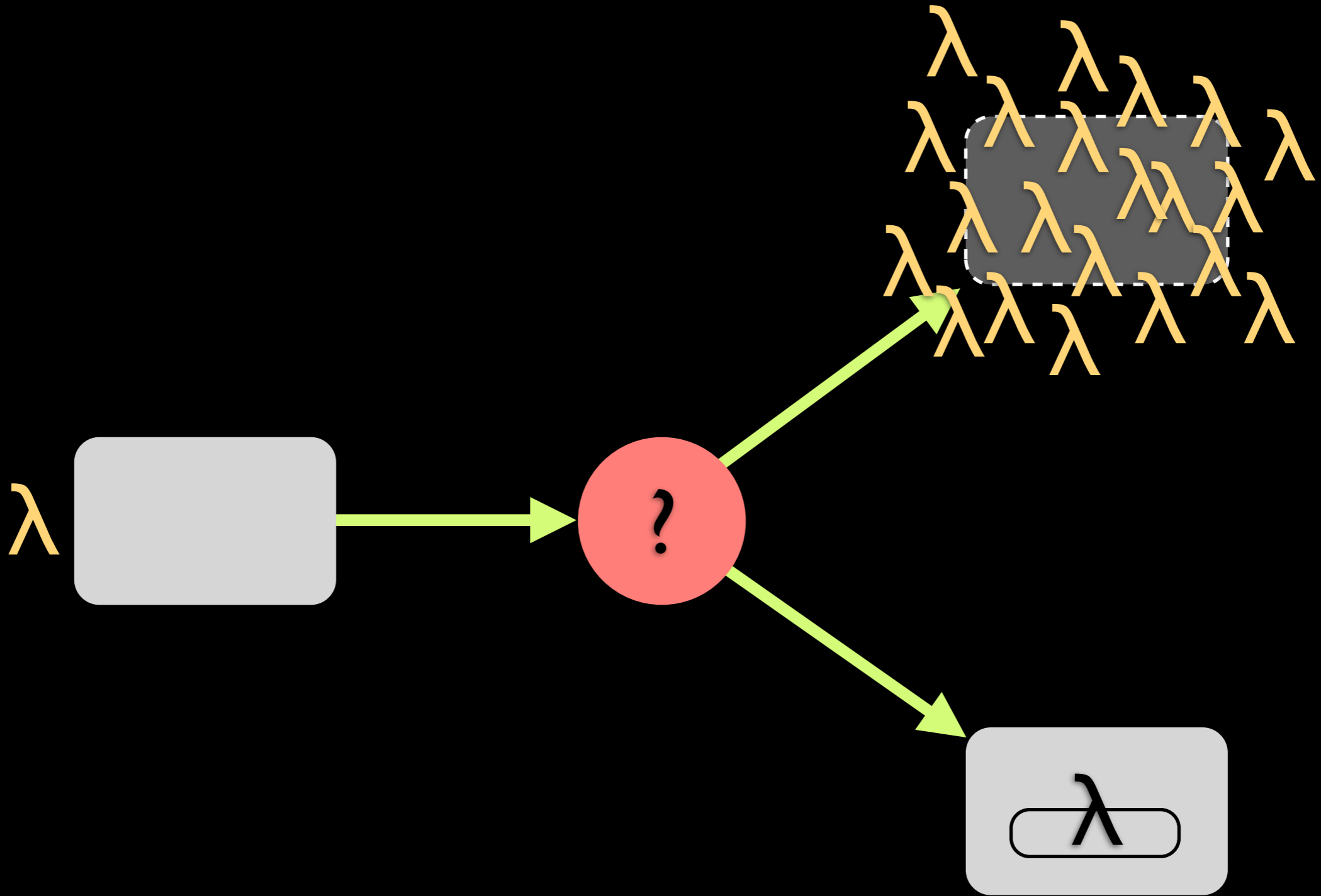

Stochastic Kinetic Analysis of Developmental Pathway Bifurcation in Phage λ -Infected *Escherichia coli* Cells

Adam Arkin,^{*,1} John Ross[†] and Harley H. McAdams^{*}

^{*}*Department of Developmental Biology and* [†]*Department of Chemistry, Stanford University, Stanford, California 94305*

Manuscript received March 5, 1998

Accepted for publication April 30, 1998

ABSTRACT

Fluctuations in rates of gene expression can produce highly erratic time patterns of protein production in individual cells and wide diversity in instantaneous protein concentrations across cell populations. When two independently produced regulatory proteins acting at low cellular concentrations competitively control a switch point in a pathway, stochastic variations in their concentrations can produce probabilistic pathway selection, so that an initially homogeneous cell population partitions into distinct phenotypic subpopulations. Many pathogenic organisms, for example, use this mechanism to randomly switch surface features to evade host responses. This coupling between molecular-level fluctuations and macroscopic phenotype selection is analyzed using the phage λ lysis-lysogeny decision circuit as a model system. The fraction of infected cells selecting the lysogenic pathway at different phage:cell ratios, predicted using a molecular-level stochastic kinetic model of the genetic regulatory circuit, is consistent with experimental observations. The kinetic model of the decision circuit uses the stochastic formulation of chemical kinetics, stochastic mechanisms of gene expression, and a statistical-thermodynamic model of promoter regulation. Conventional deterministic kinetics cannot be used to predict statistics of regulatory systems that produce probabilistic outcomes. Rather, a stochastic kinetic analysis must be used to predict statistics of regulatory outcomes for such stochastically regulated systems.

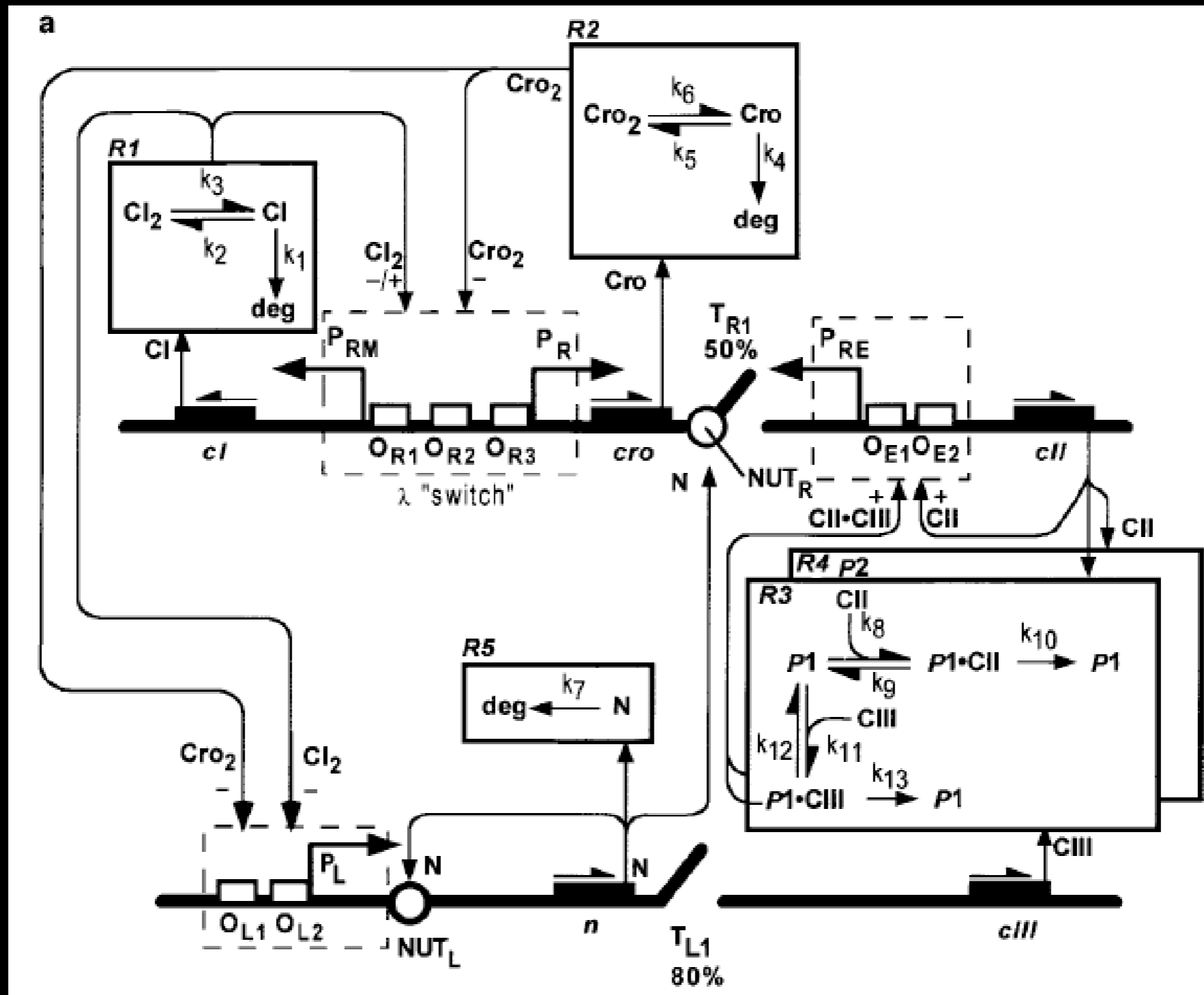

Arkin, Ross & McAdams
 Stochastic Kinetic Analysis of Developmental Pathway
 Bifurcation in Phage-Infected Escherichia coli Cells
 Genetics 149:1633 (1998)

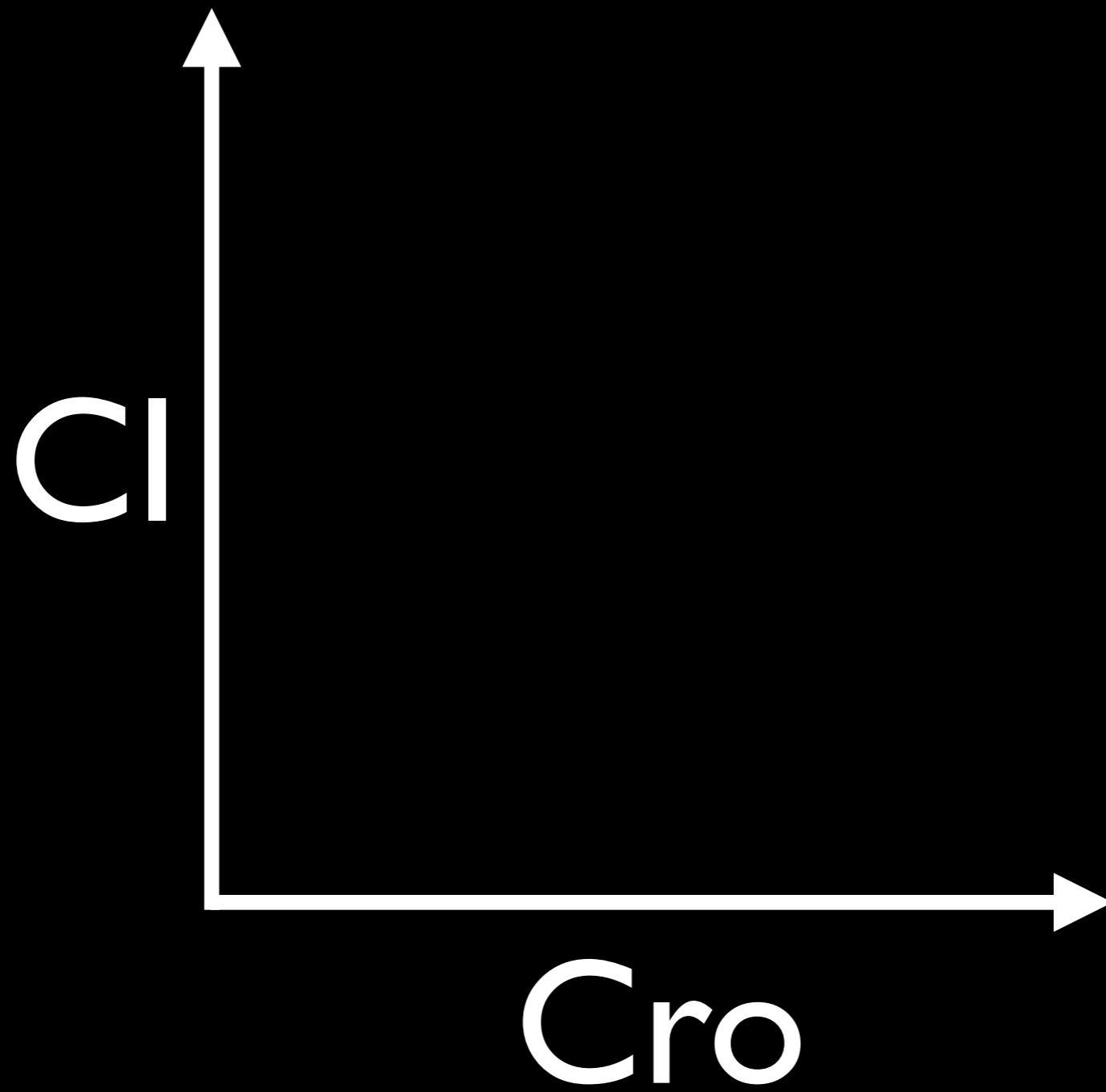

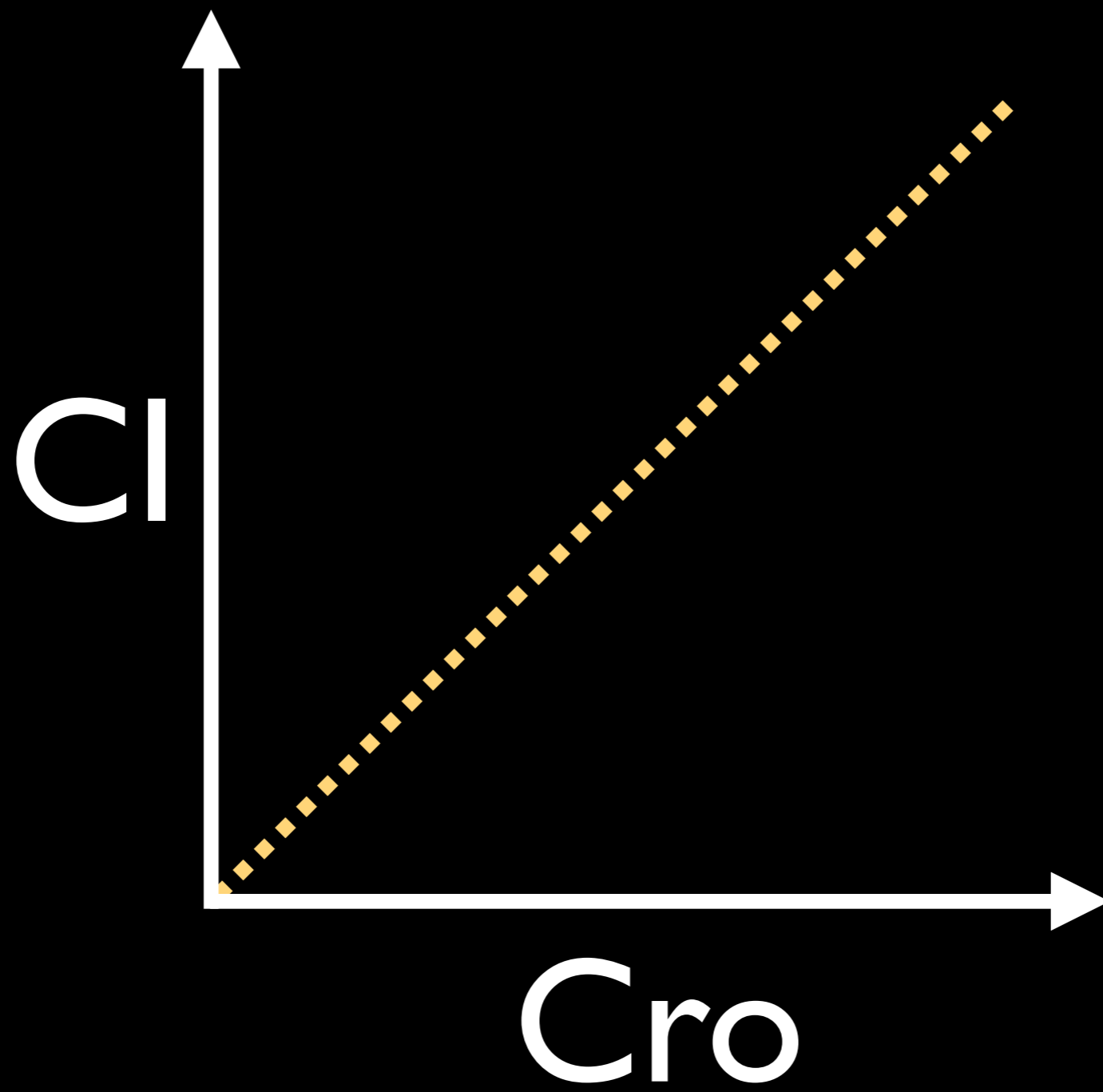

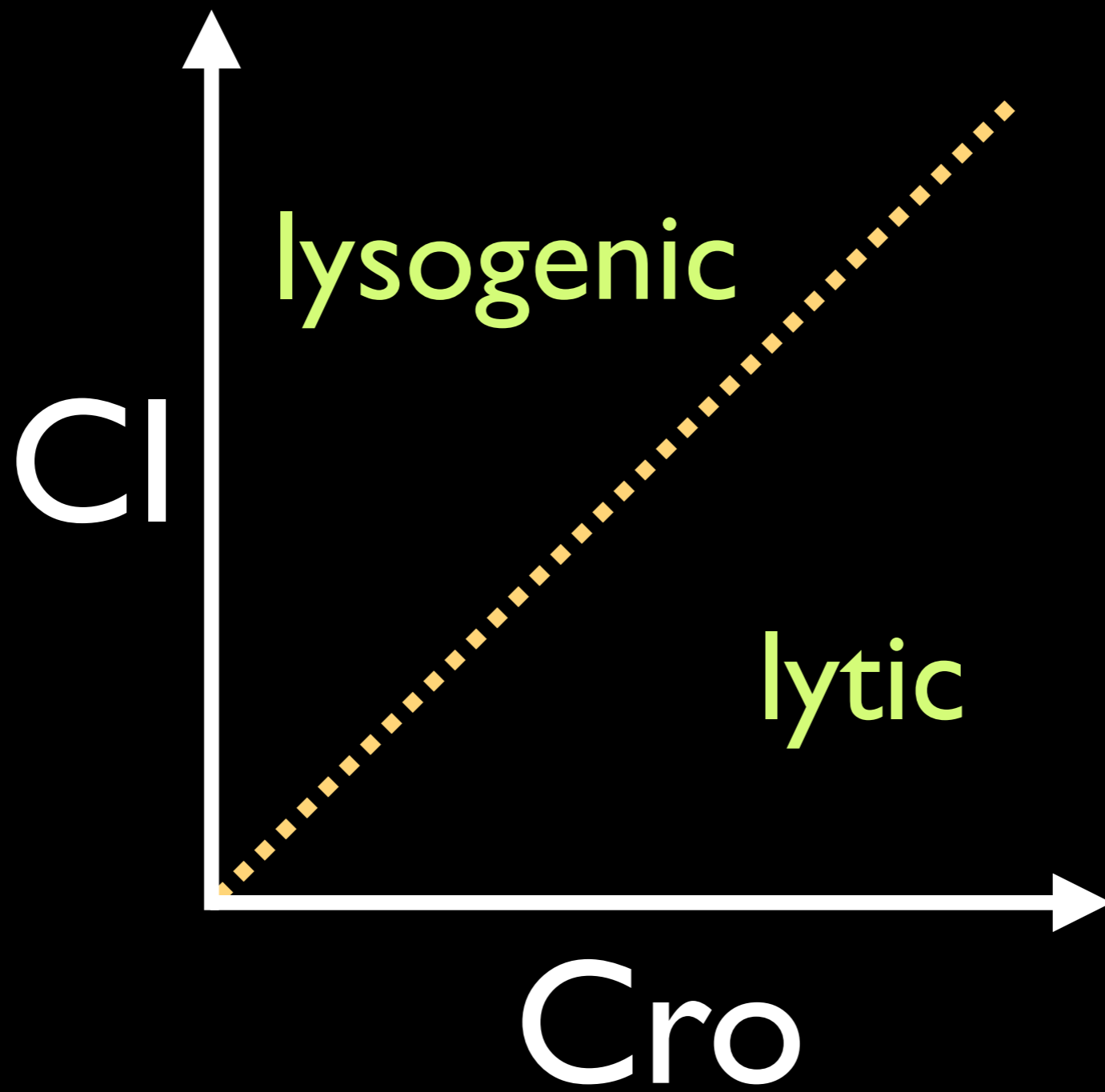

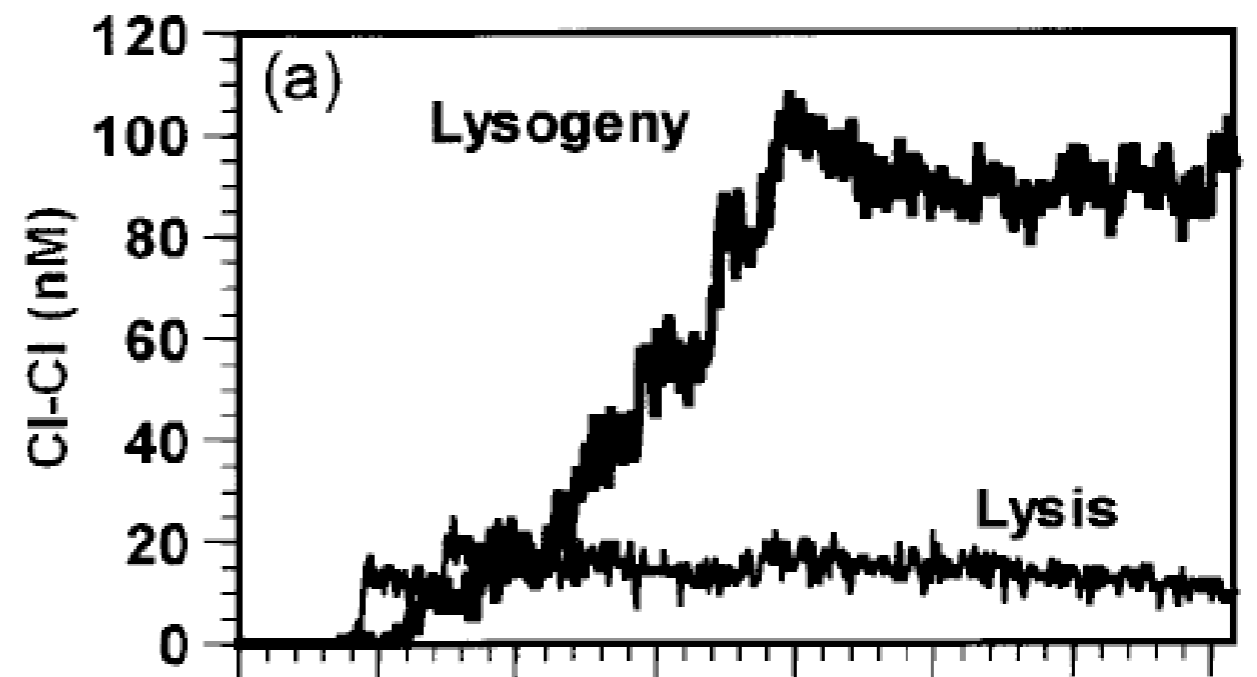
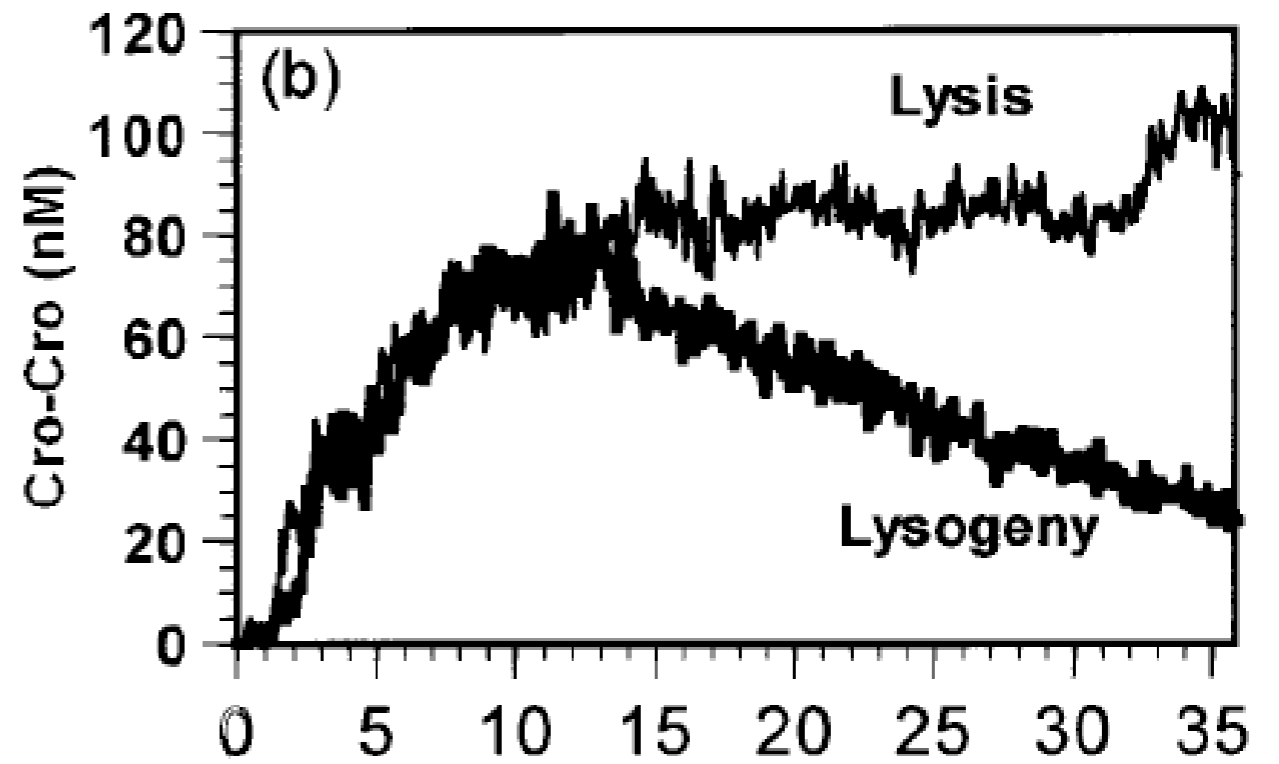
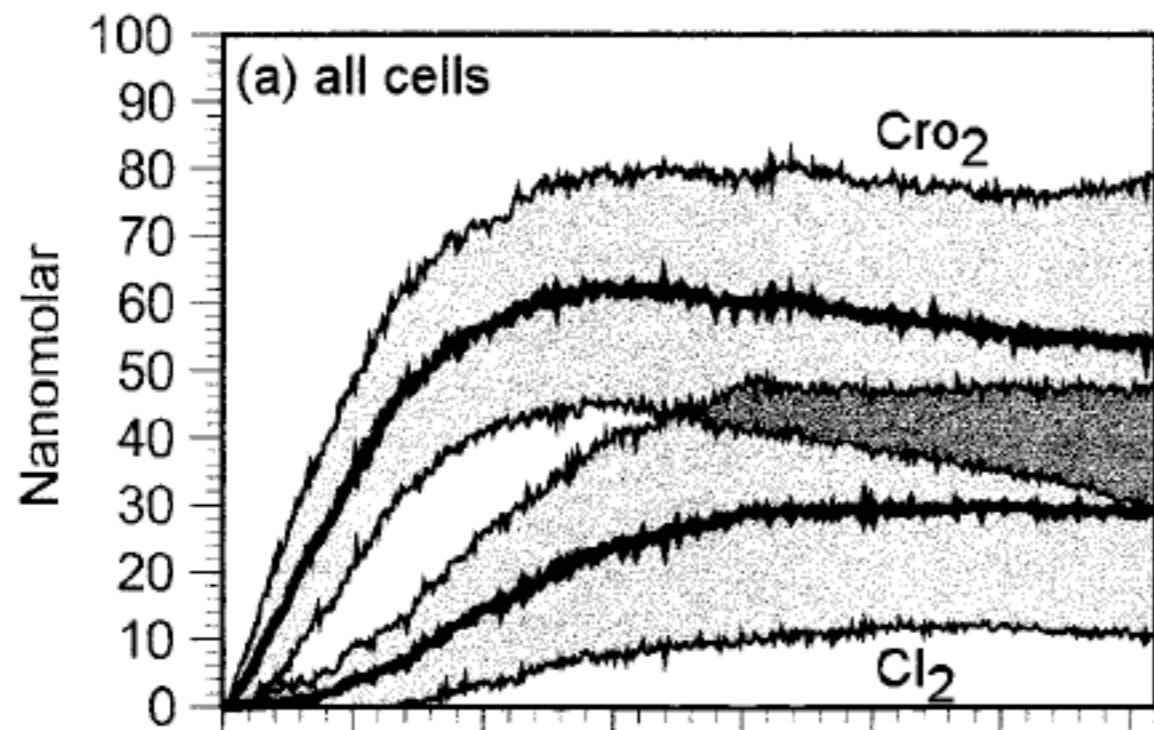

Arkin, Ross & McAdams
 Stochastic Kinetic Analysis of Developmental Pathway
 Bifurcation in Phage-Infected *Escherichia coli* Cells
 Genetics 149:1633 (1998)

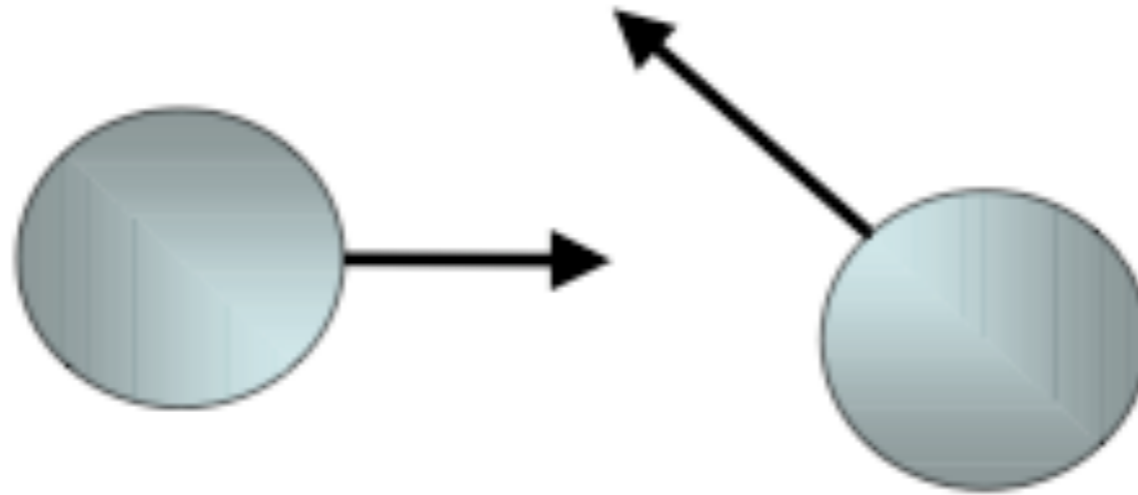

$$c_v \delta t = V^{-1} \pi d_{12}^2 (8kT/\pi m_{12})^{0.5} e^{(-\mu_v/kT)} \delta t$$

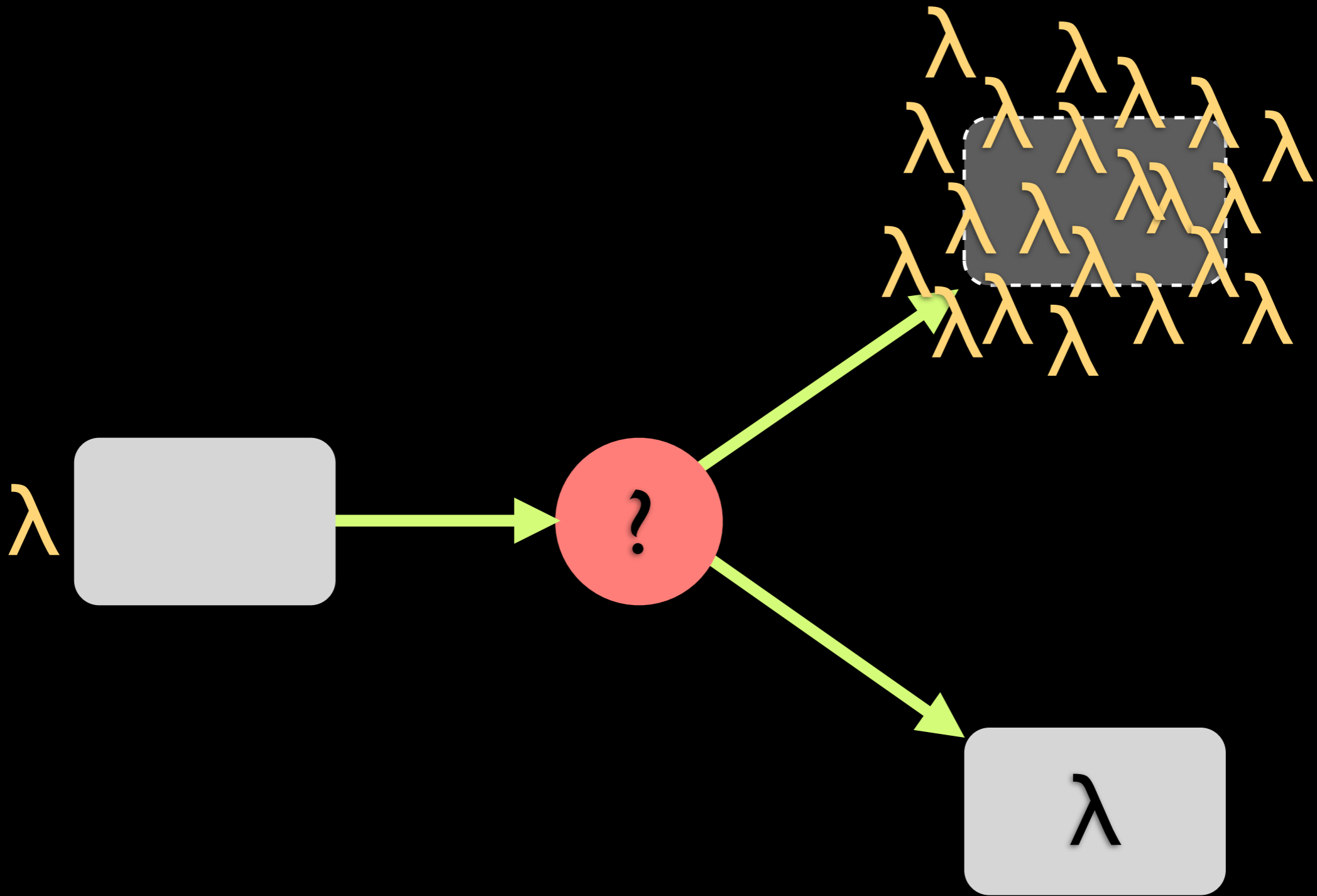

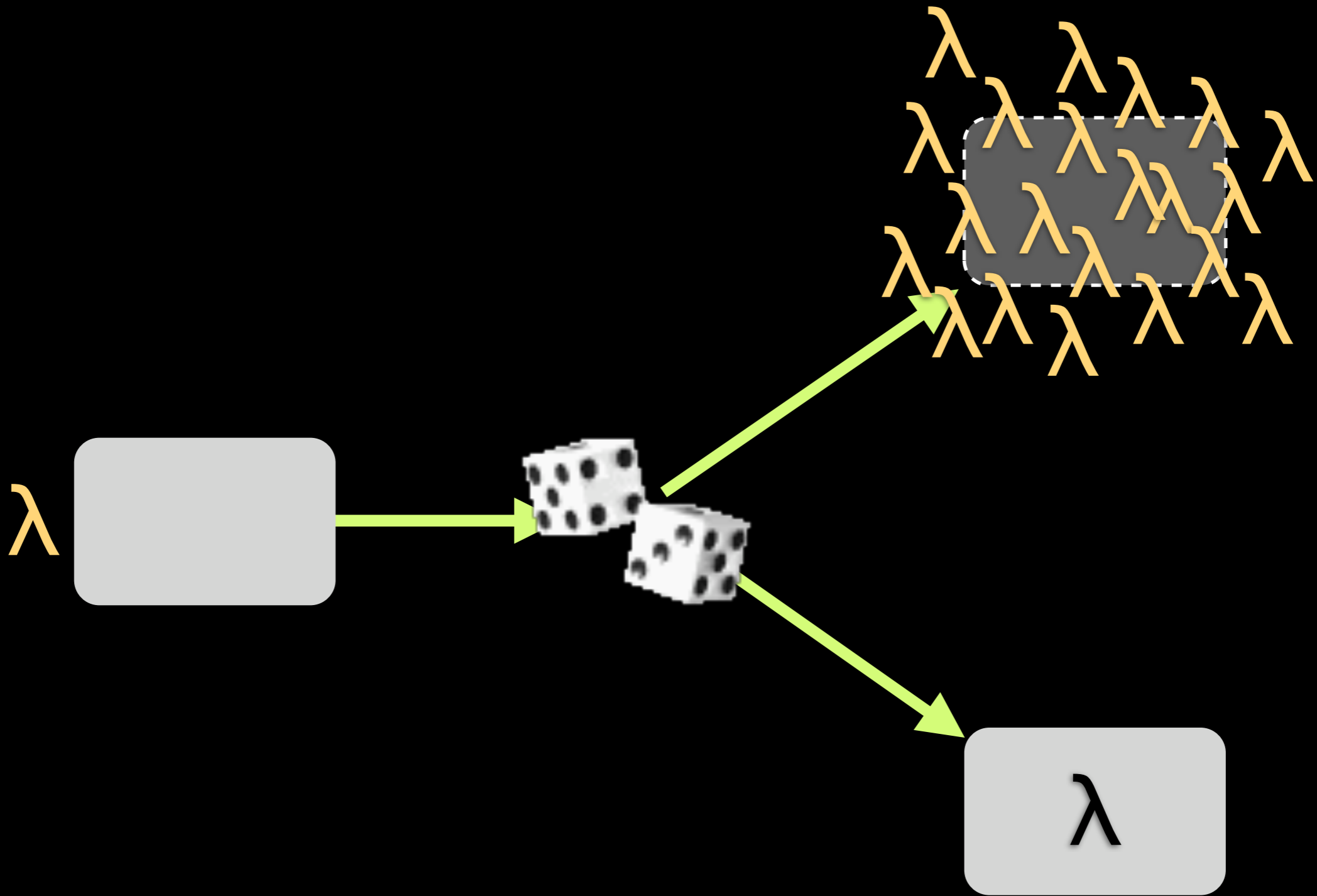

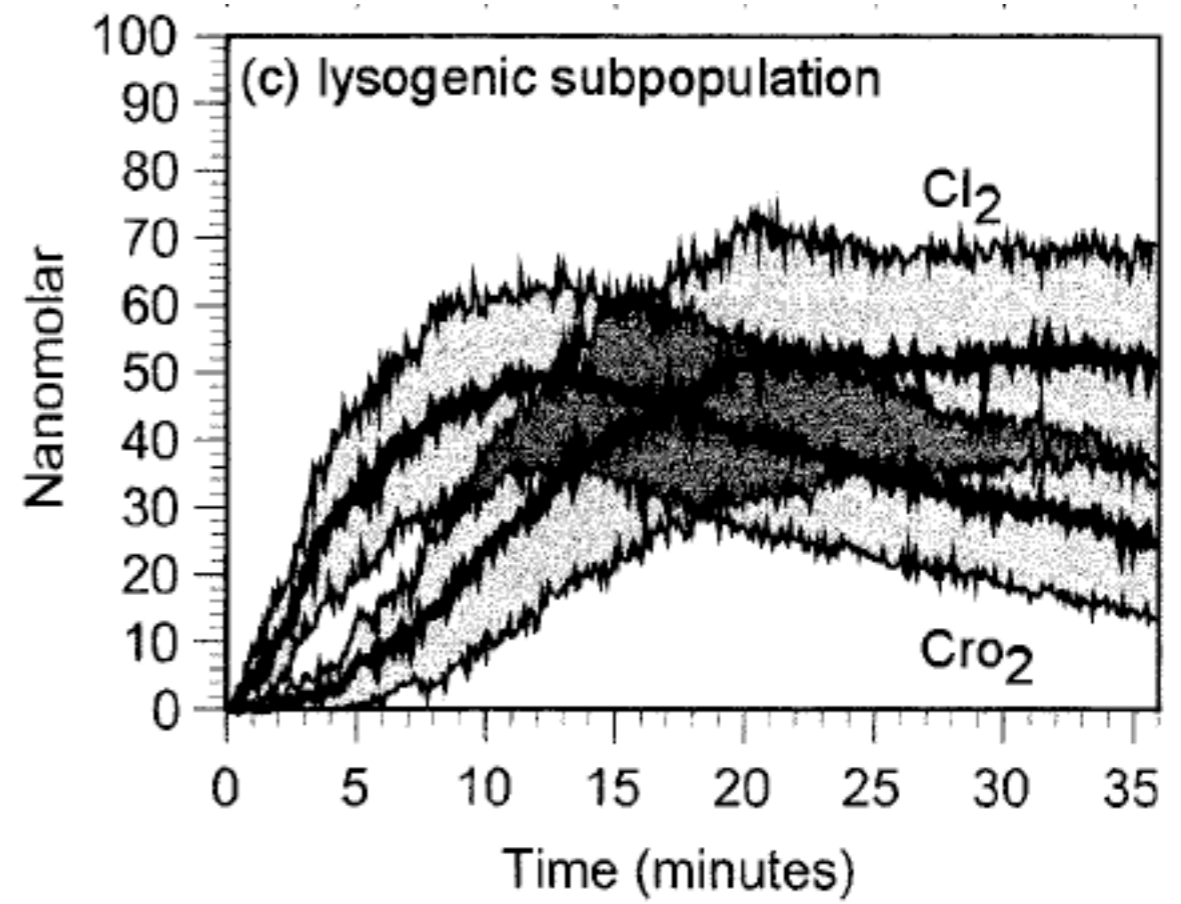
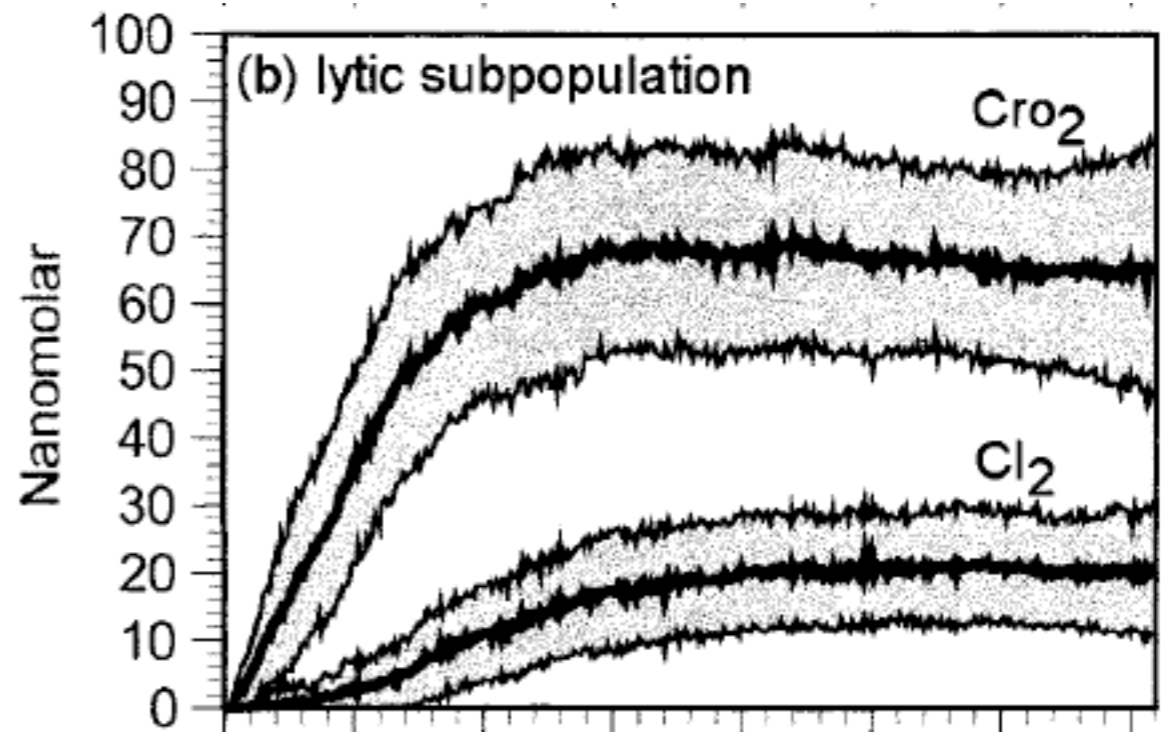
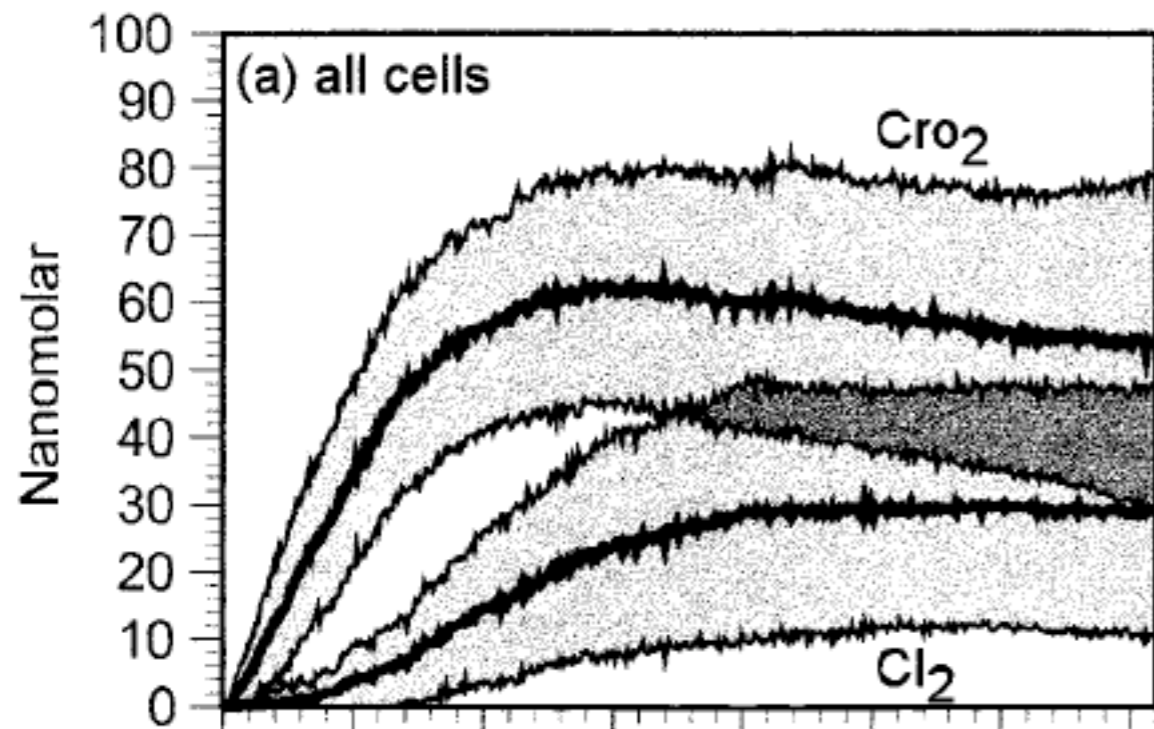

Arkin, Ross & McAdams
 Stochastic Kinetic Analysis of Developmental Pathway
 Bifurcation in Phage-Infected *Escherichia coli* Cells
 Genetics 149:1633 (1998)

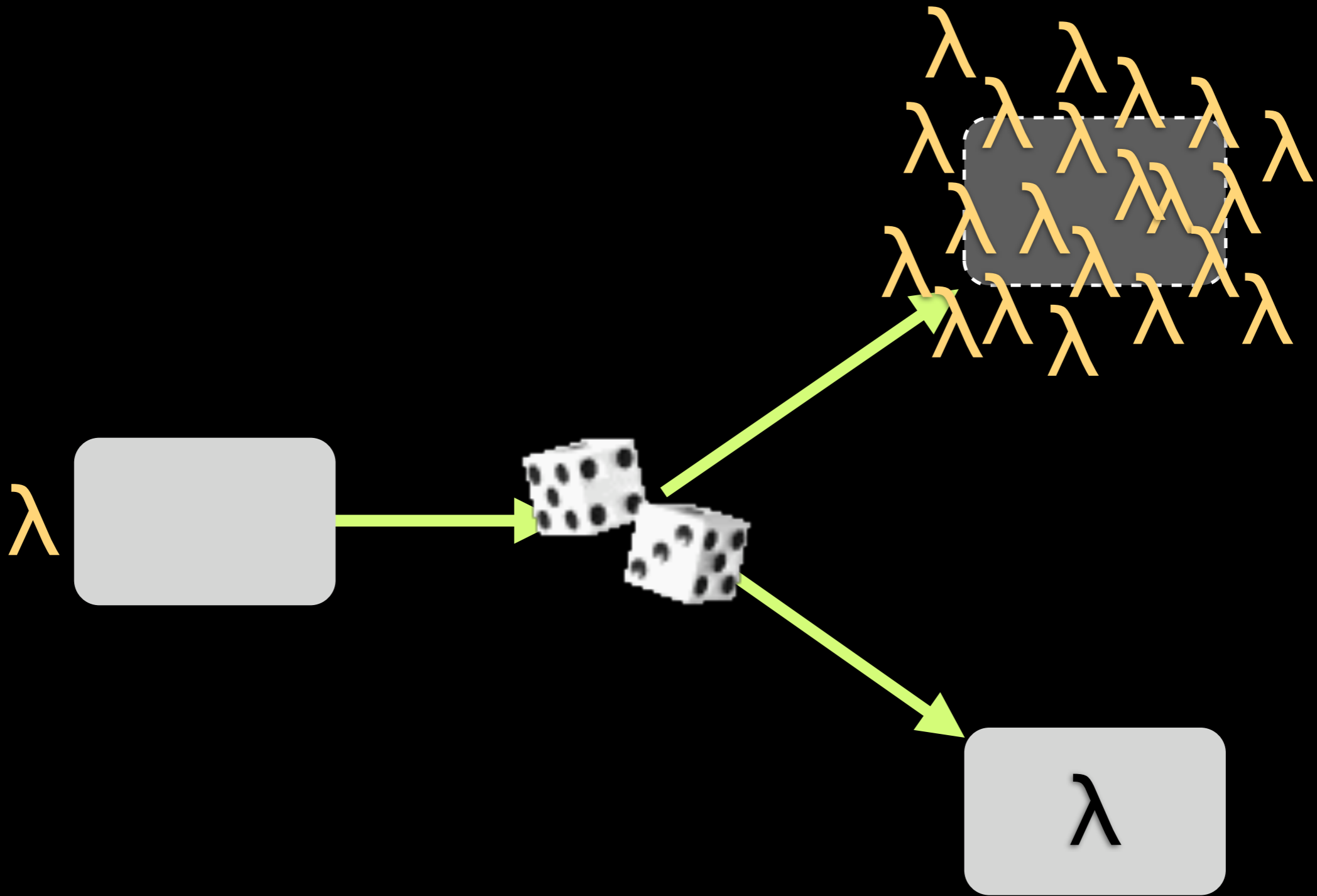

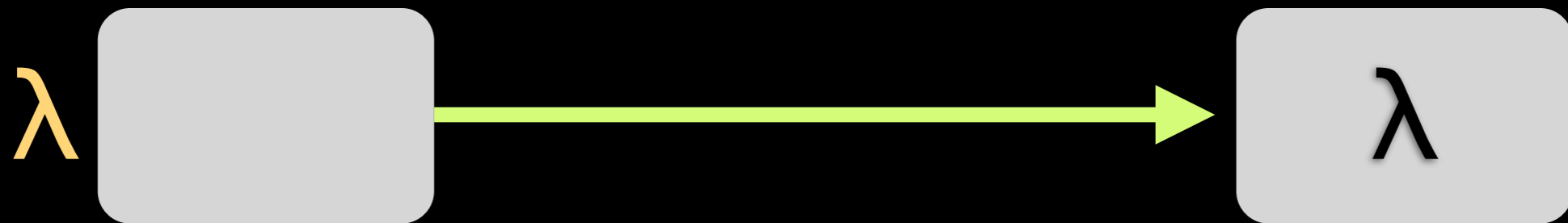
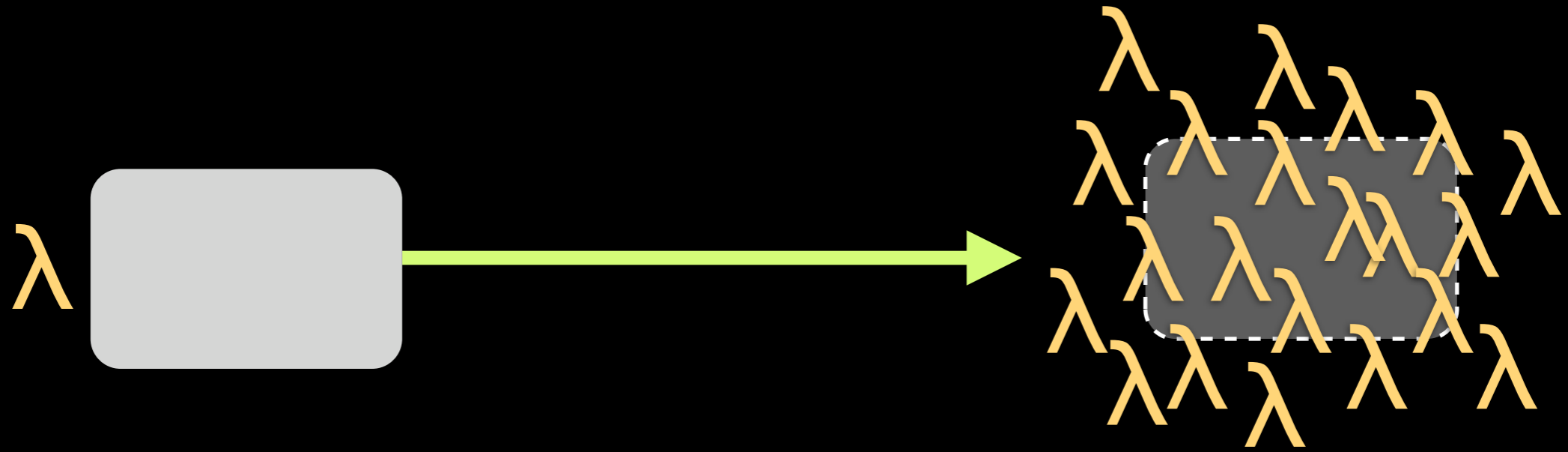

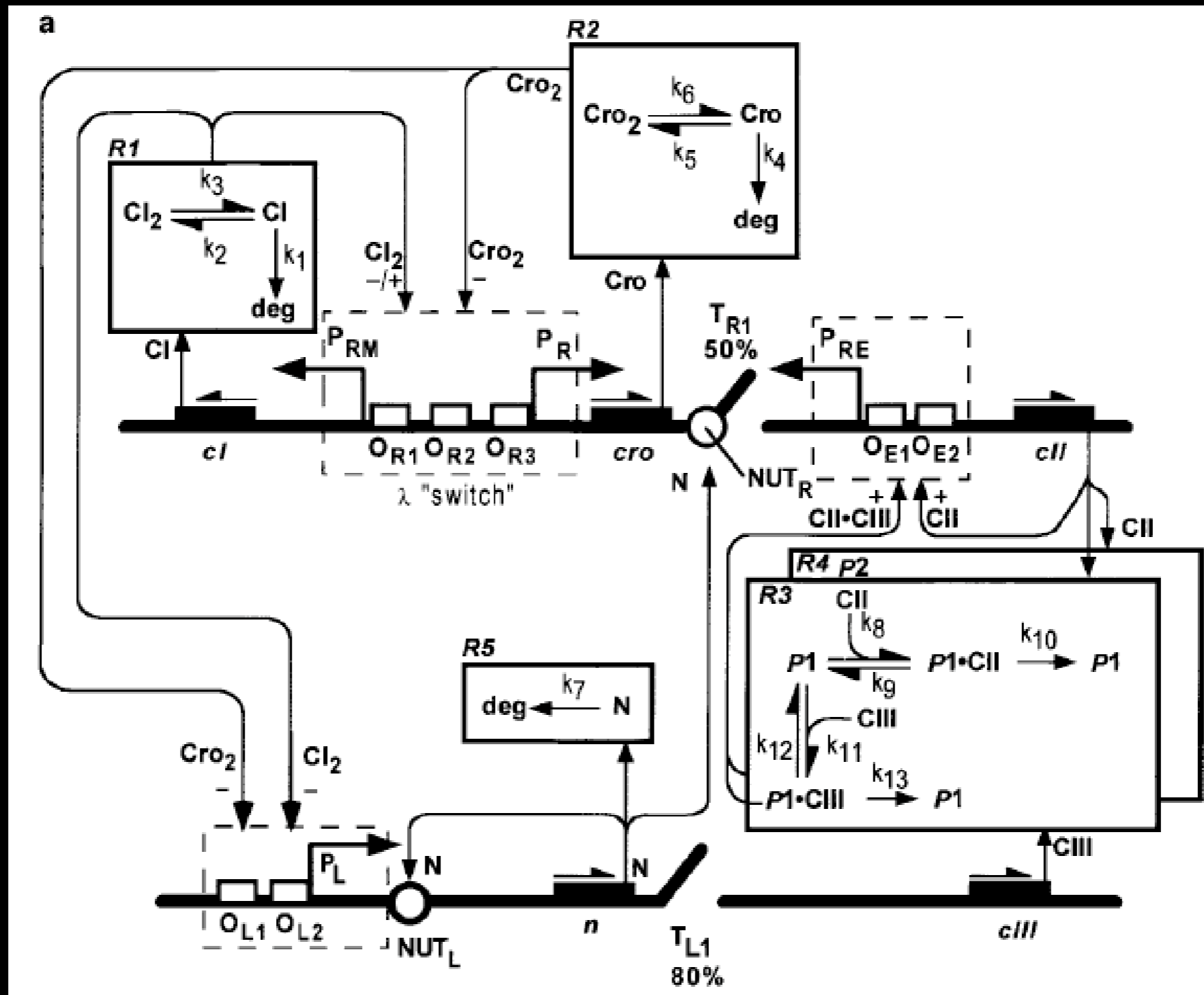

Arkin, Ross & McAdams
 Stochastic Kinetic Analysis of Developmental Pathway
 Bifurcation in Phage-Infected Escherichia coli Cells
 Genetics 149:1633 (1998)

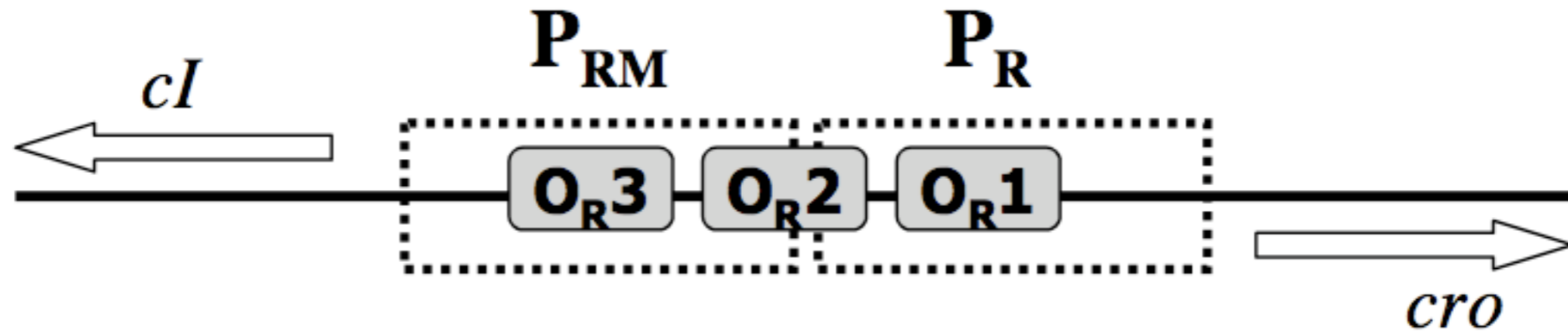
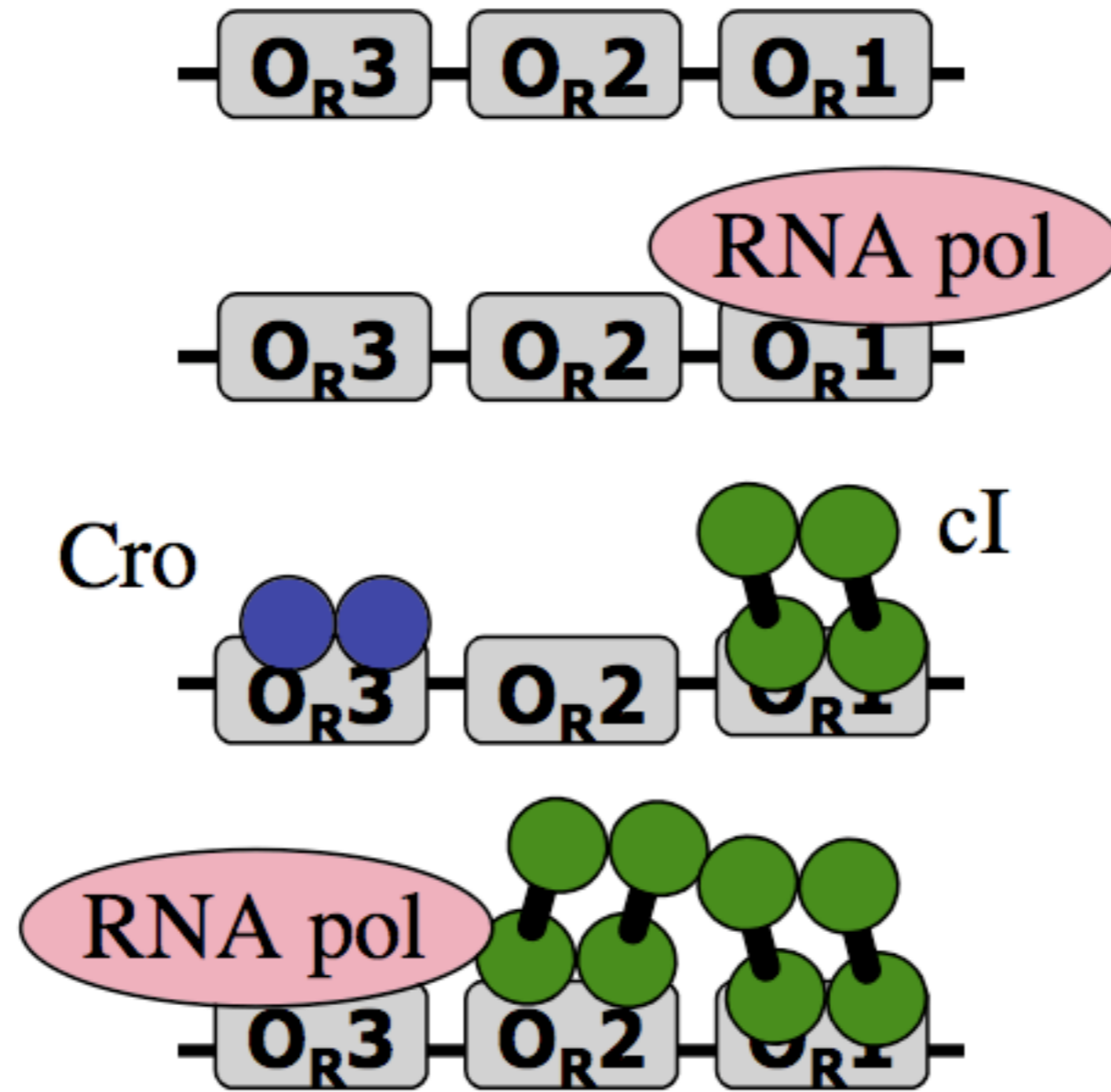

TABLE 3
Binding states of O_R

State	P_{RM}	O_{R3}	O_{R2}	O_{R1}	P_R	ΔG_s (kcal mol ⁻¹)	$i(s)$	$j(s)$	$k(s)$
1						0.0	0	0	0
2				r2		-11.6	1	0	0
3			r2			-10.1	1	0	0
4		r2				-10.1	1	0	0
5			r2	r2		-23.7	2	0	0
6		r2		r2		-21.7	2	0	0
7		r2	r2			-22.2	2	0	0
8		r2	r2	r2		-33.8	3	0	0
9				c2		-10.8	0	1	0
10			c2			-10.8	0	1	0
11		c2				-12.1	0	1	0
12			c2	c2		-21.6	0	2	0
13		c2		c2		-22.9	0	2	0
14		c2	c2			-22.9	0	2	0
15		c2	c2	c2		-33.7	0	3	0
16			c2	r2		-22.4	1	1	0
17		c2		r2		-23.7	1	1	0
18		c2	c2	r2		-34.5	1	2	0
19		c2	r2			-22.2	1	1	0
20			r2	c2		-20.9	1	1	0
21		c2	r2	c2		-33.0	1	2	0
22		r2	c2			-20.9	1	1	0
23		r2		c2		-20.9	1	1	0
24		r2	c2	c2		-31.7	1	2	0
25		c2	r2	r2		-35.8	2	1	0
26		r2	c2	r2		-32.5	2	1	0
27		r2	r2	c2		-33.0	2	1	0
28					RNAP	-12.5	0	0	1
29		r2			RNAP	-22.6	1	0	1
30		c2			RNAP	-24.6	0	1	1
31	RNAP		r2			-21.6	1	0	1
32	RNAP		r2	r2		-35.2	2	0	1
33	RNAP		r2	c2		-32.4	1	1	1
34	RNAP					-9.9	0	0	1
35	RNAP			r2		-21.5	1	0	1
36	RNAP			c2		-20.7	0	1	1
37	RNAP		c2			-20.7	0	1	1
38	RNAP		c2	r2		-32.3	1	1	1
39	RNAP		c2	c2		-31.5	0	2	1
40	RNAP				RNAP	-22.4	0	0	2

Shea & Ackers care of:
Reinitz J, Vaisnys JR.
J Theor Biol. 145(3):295-318 (1990).



etc.

Small bacterium (0.8 μm^3)

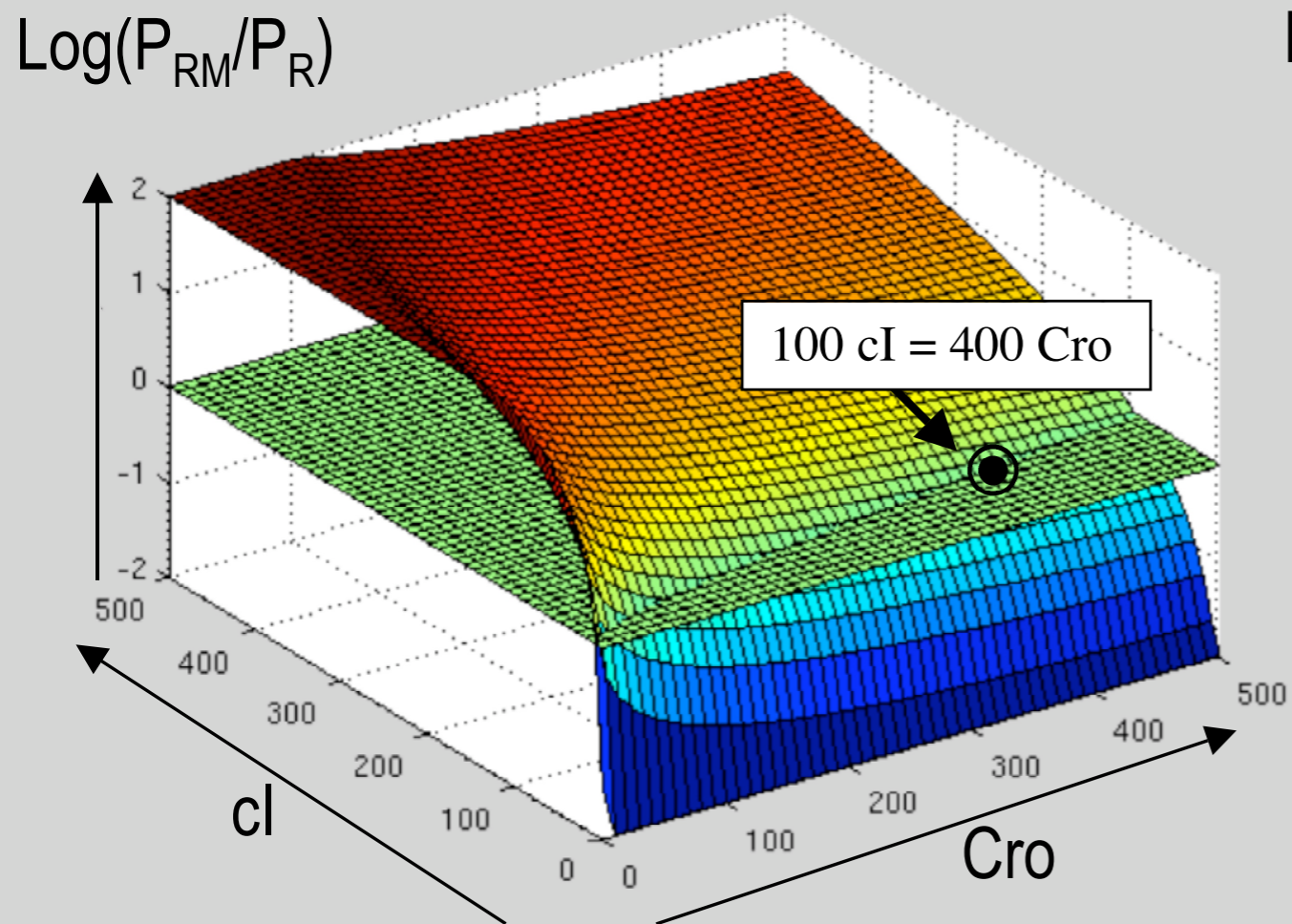

Large bacterium (3 μm^3)

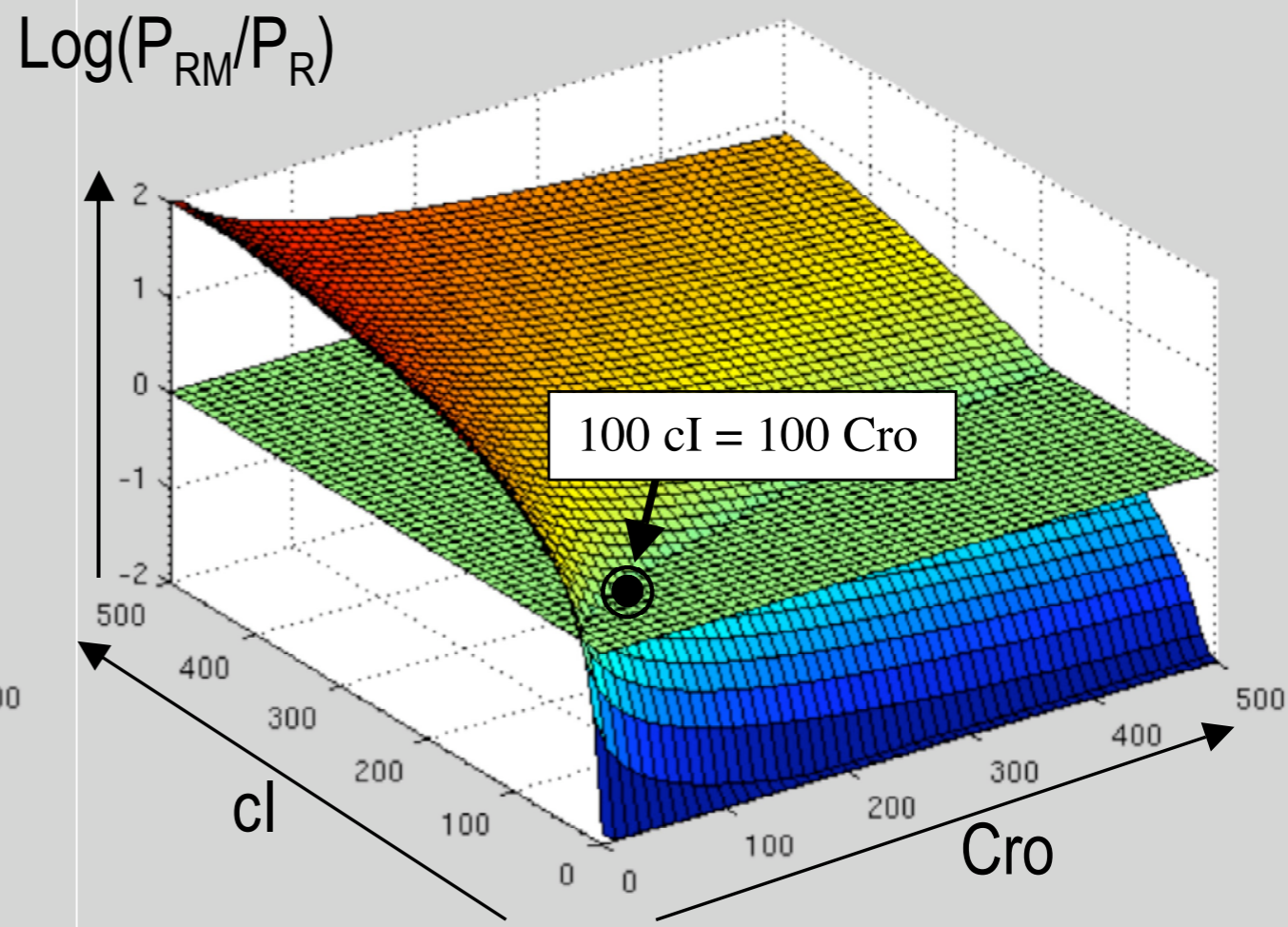

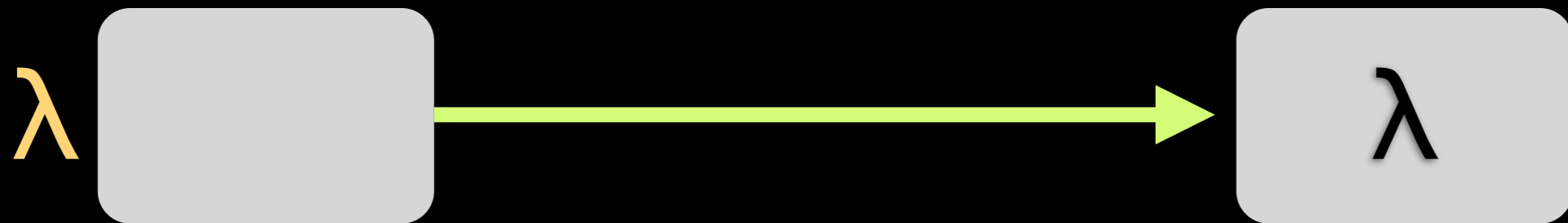
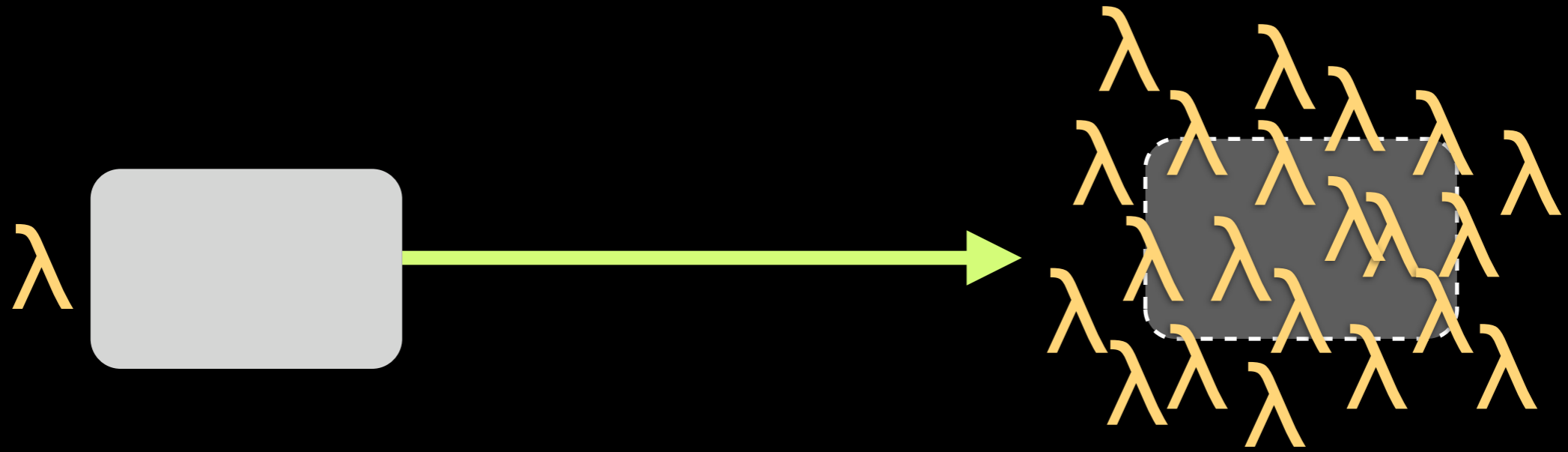

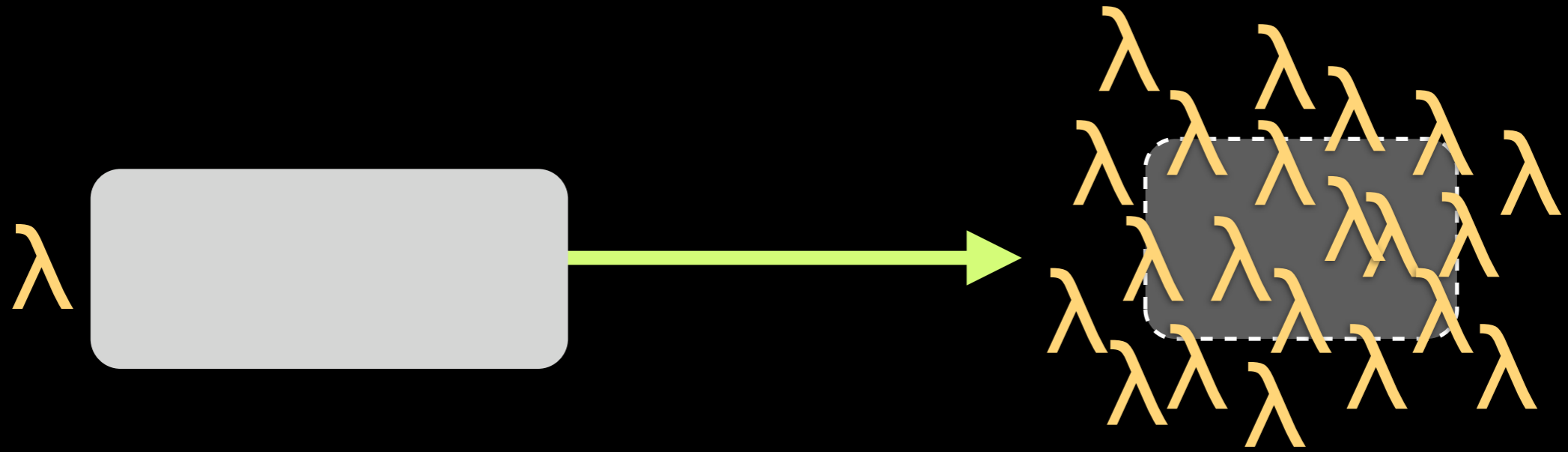

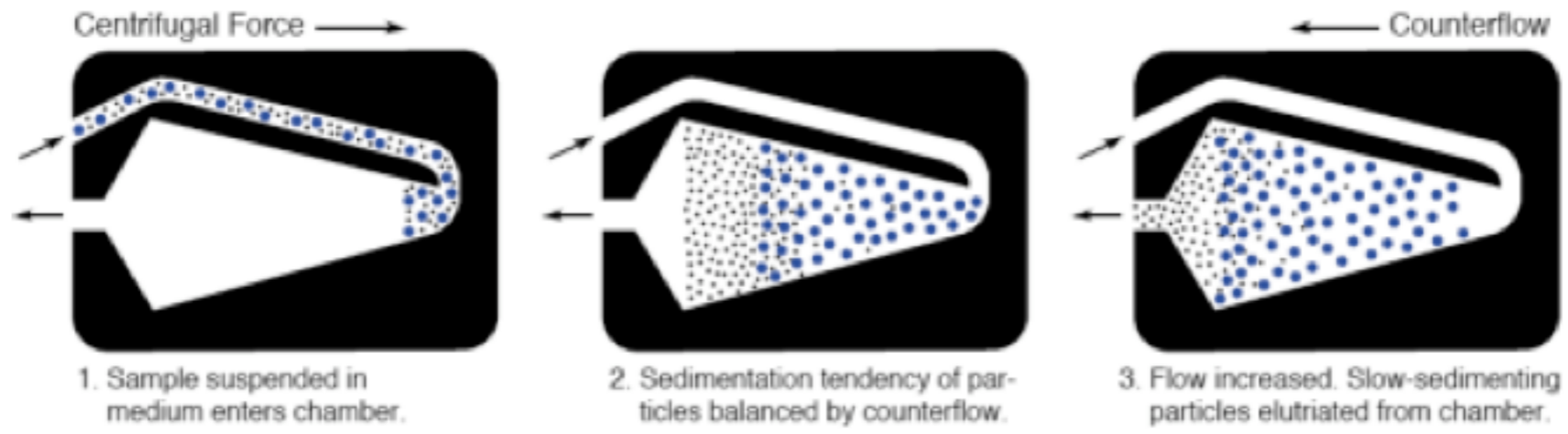

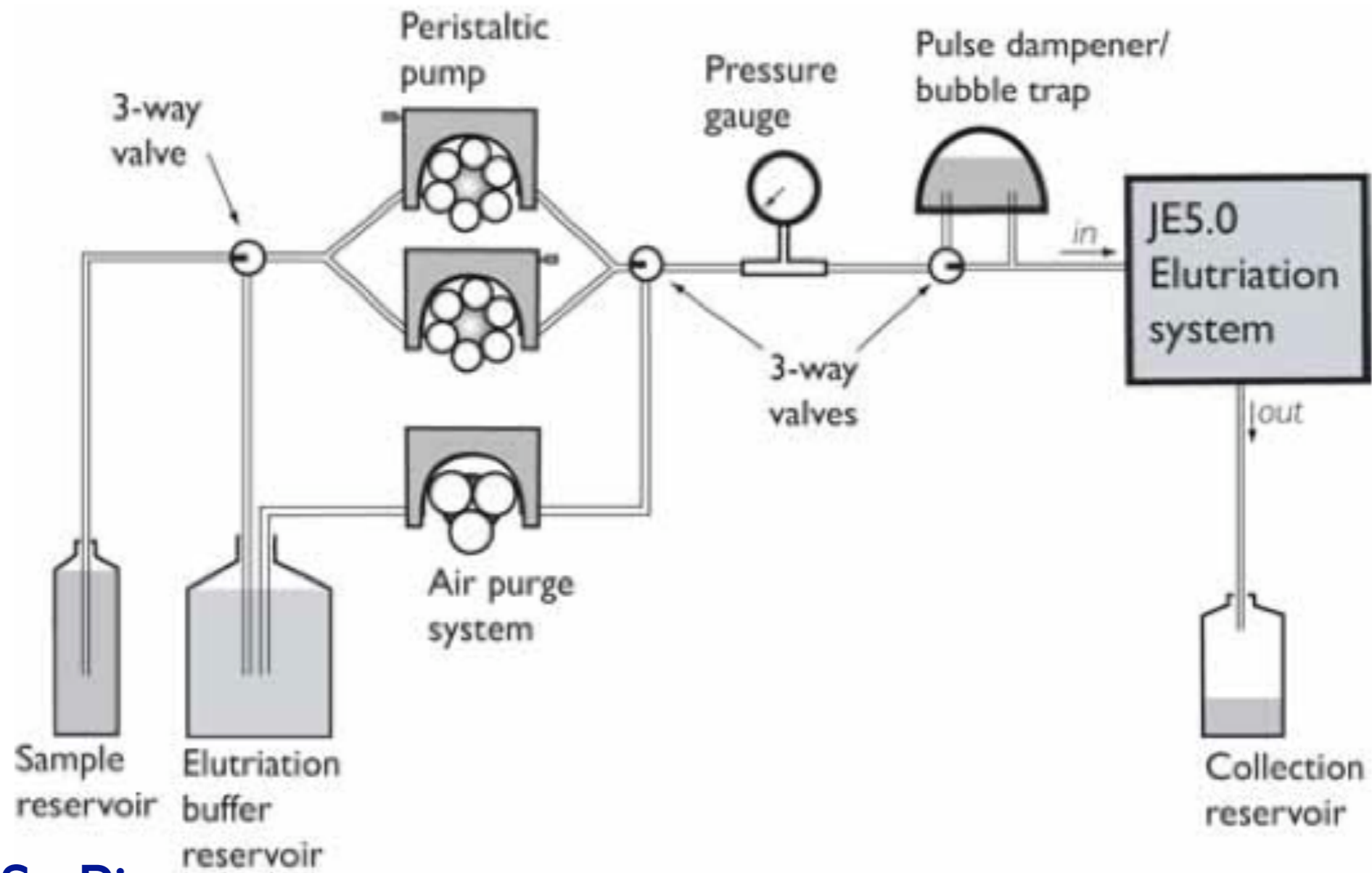
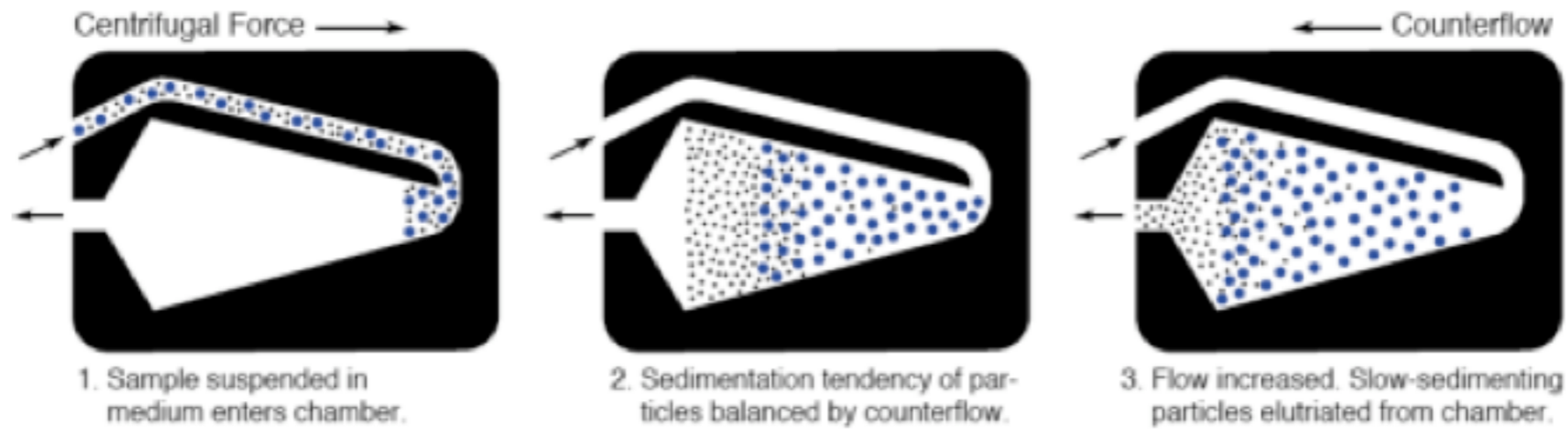

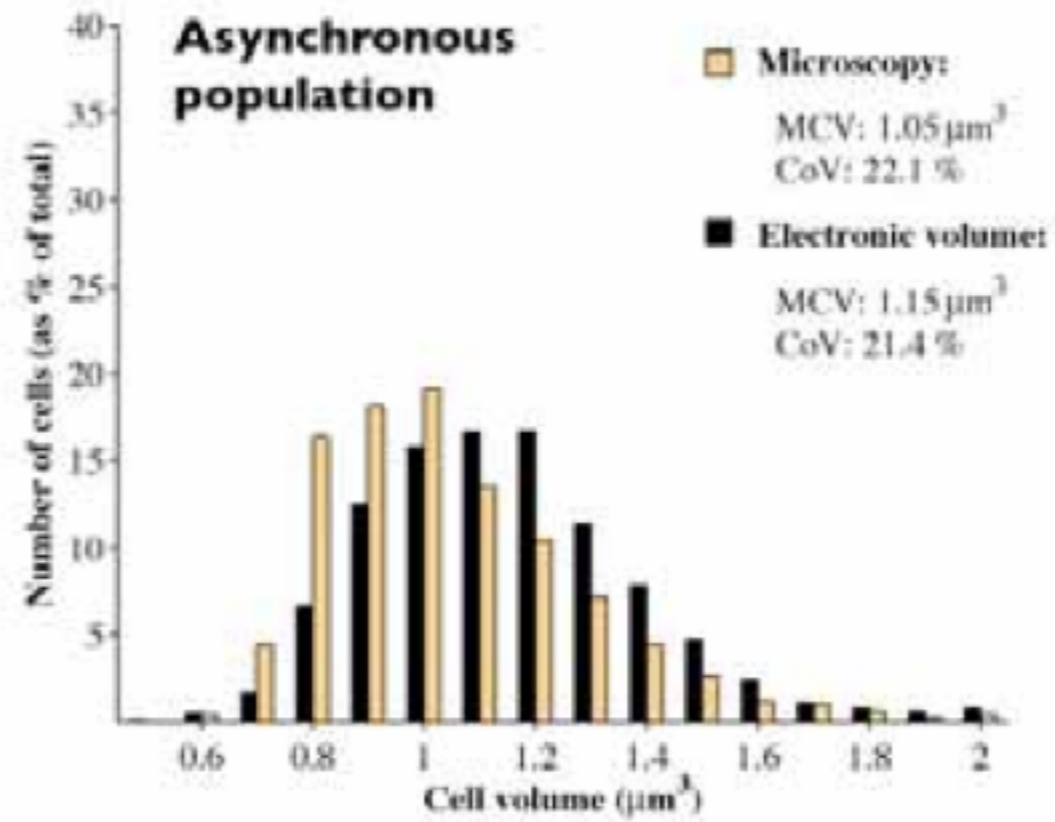

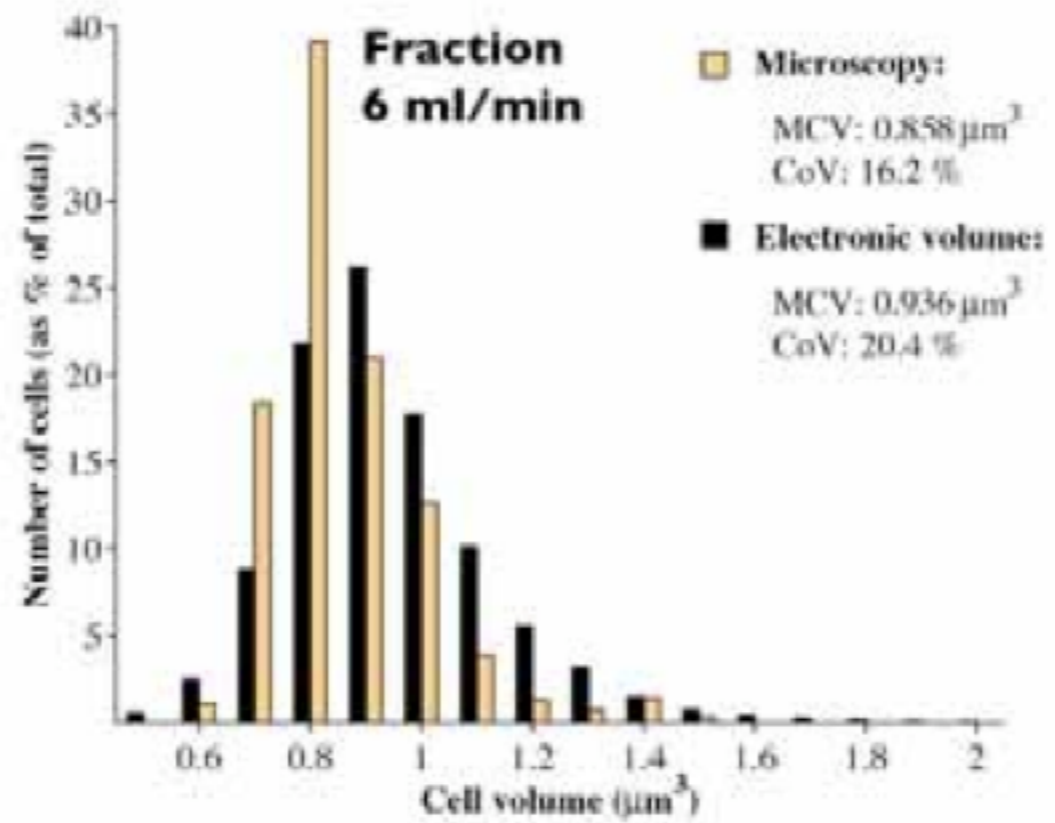

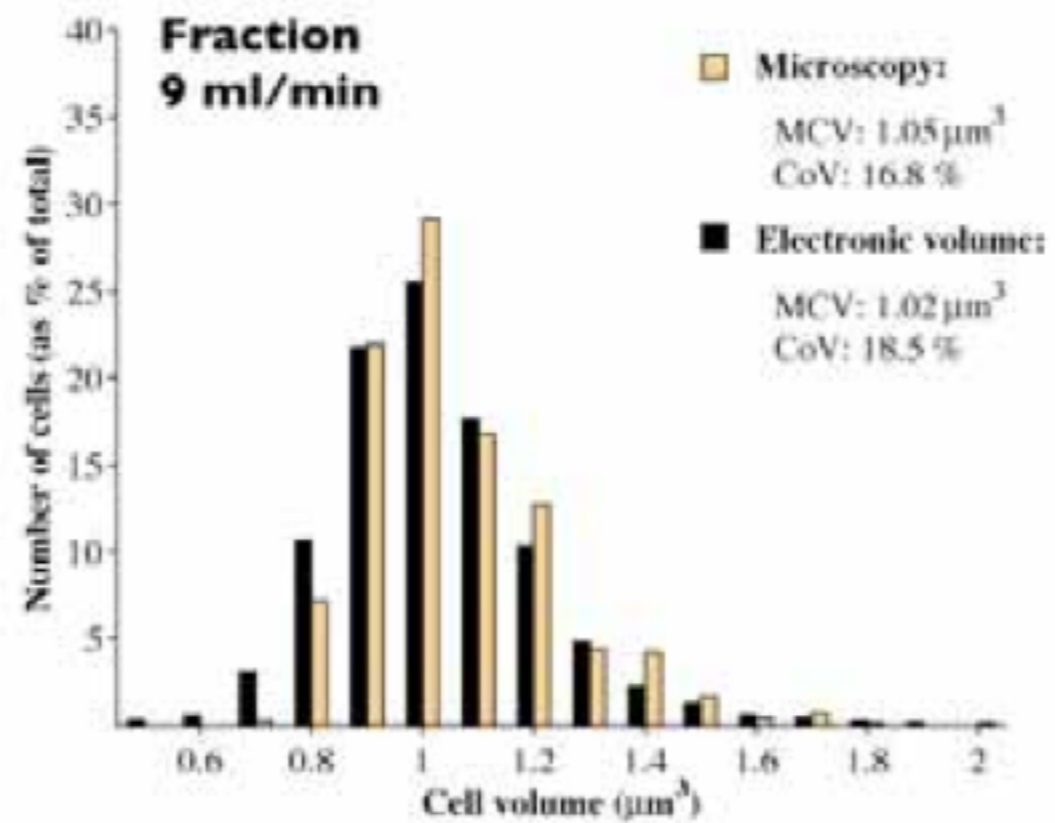

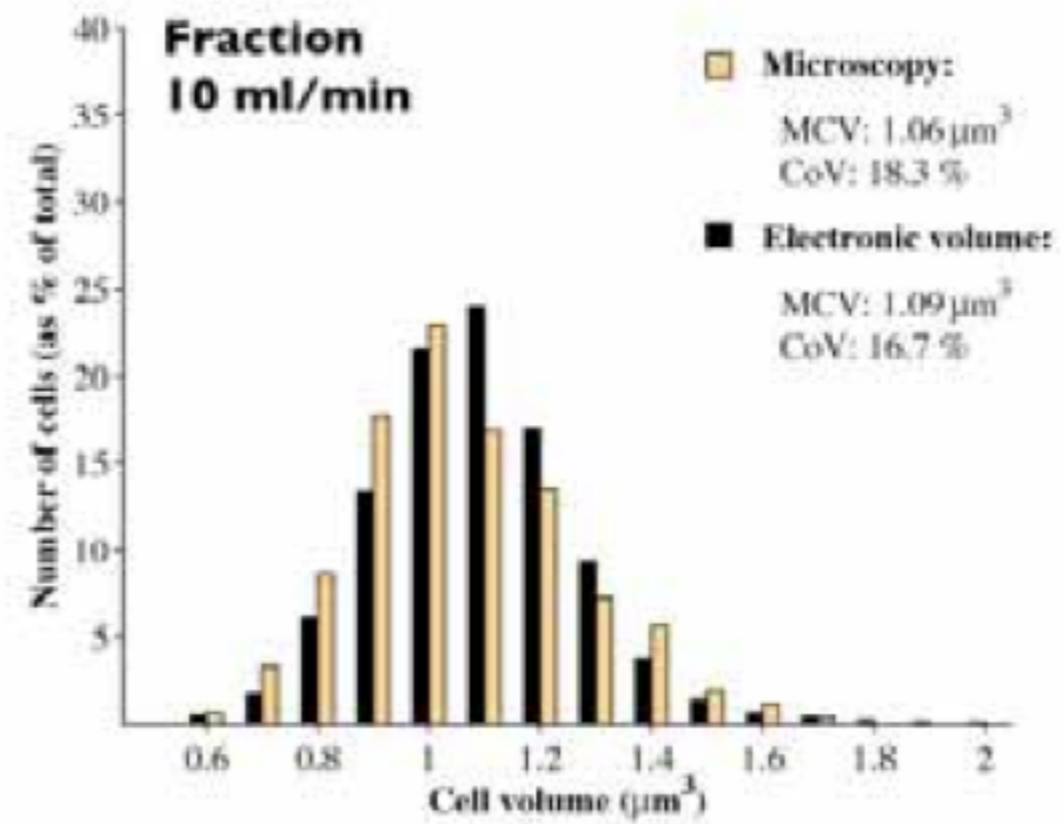

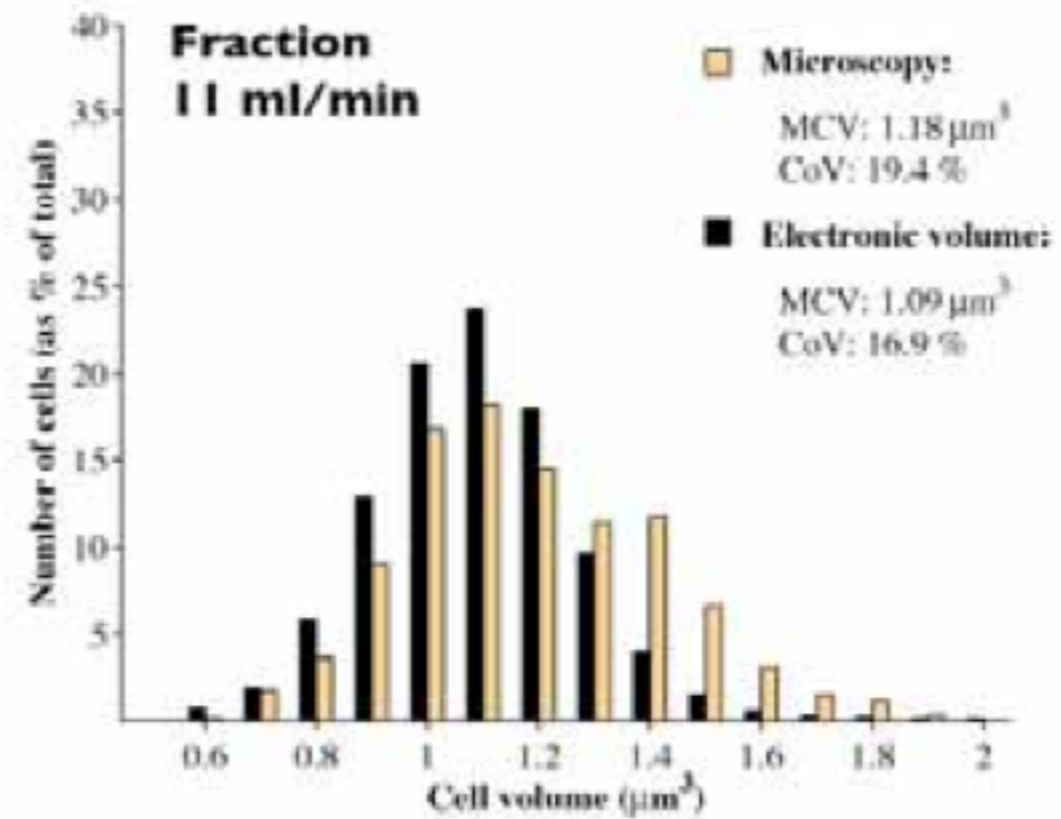

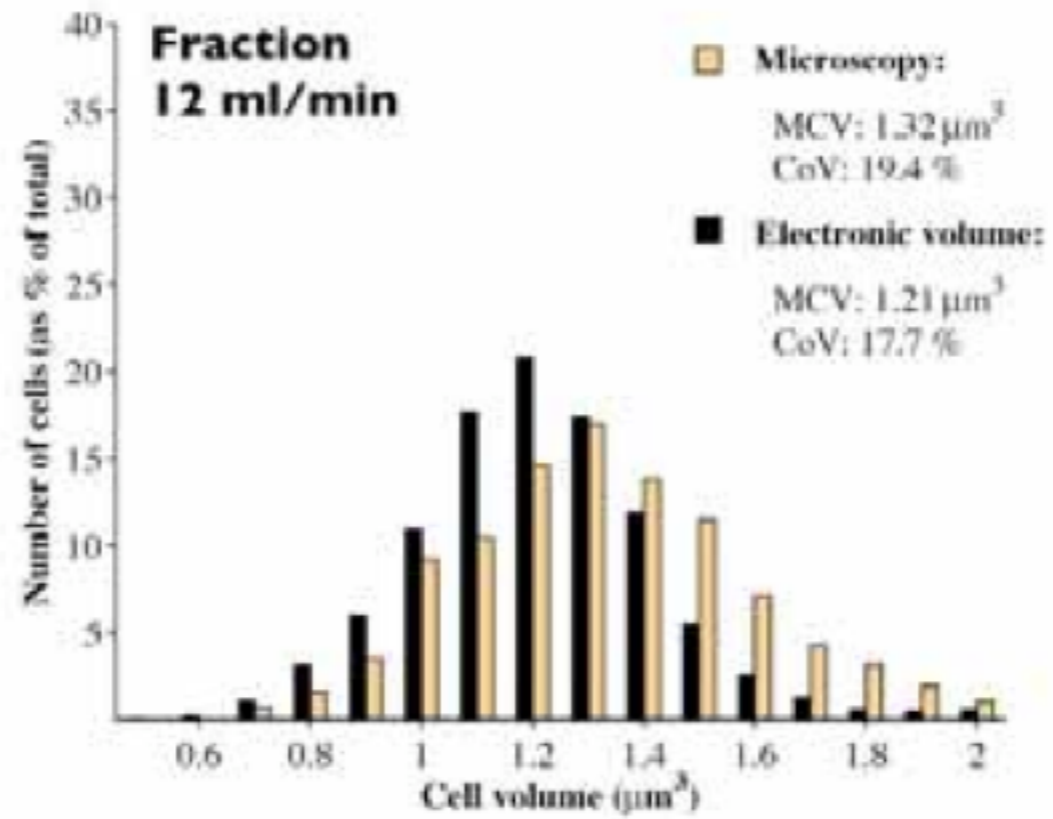

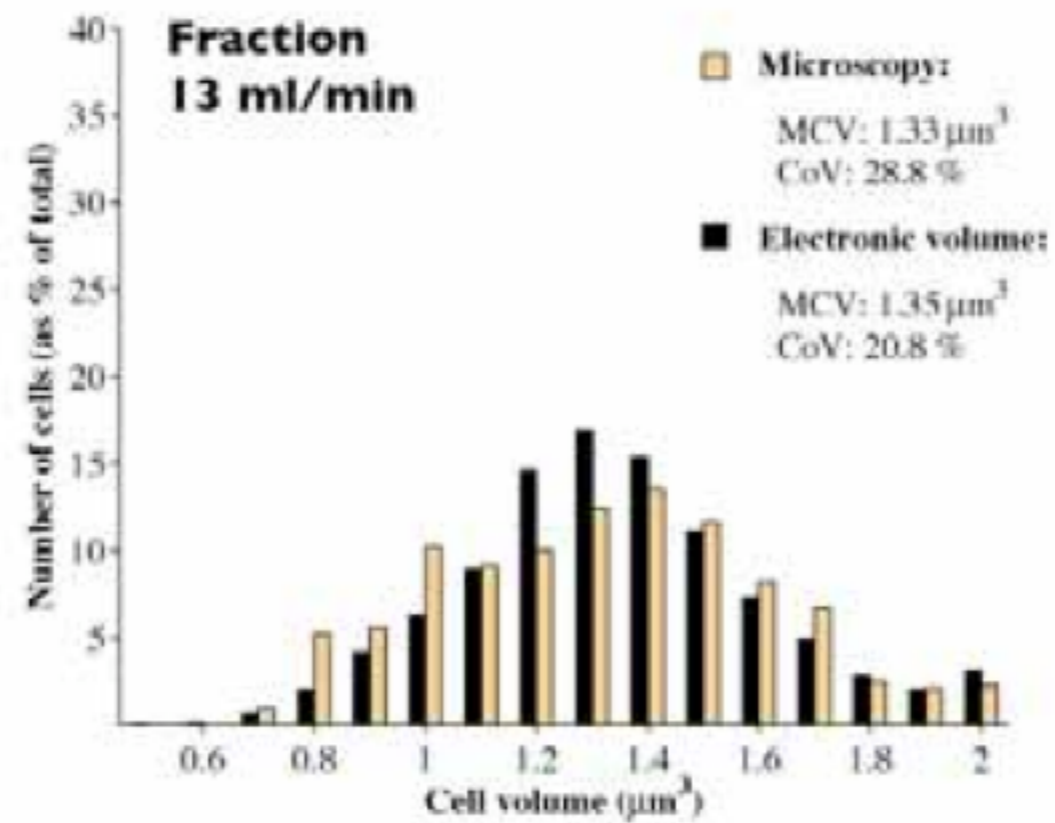

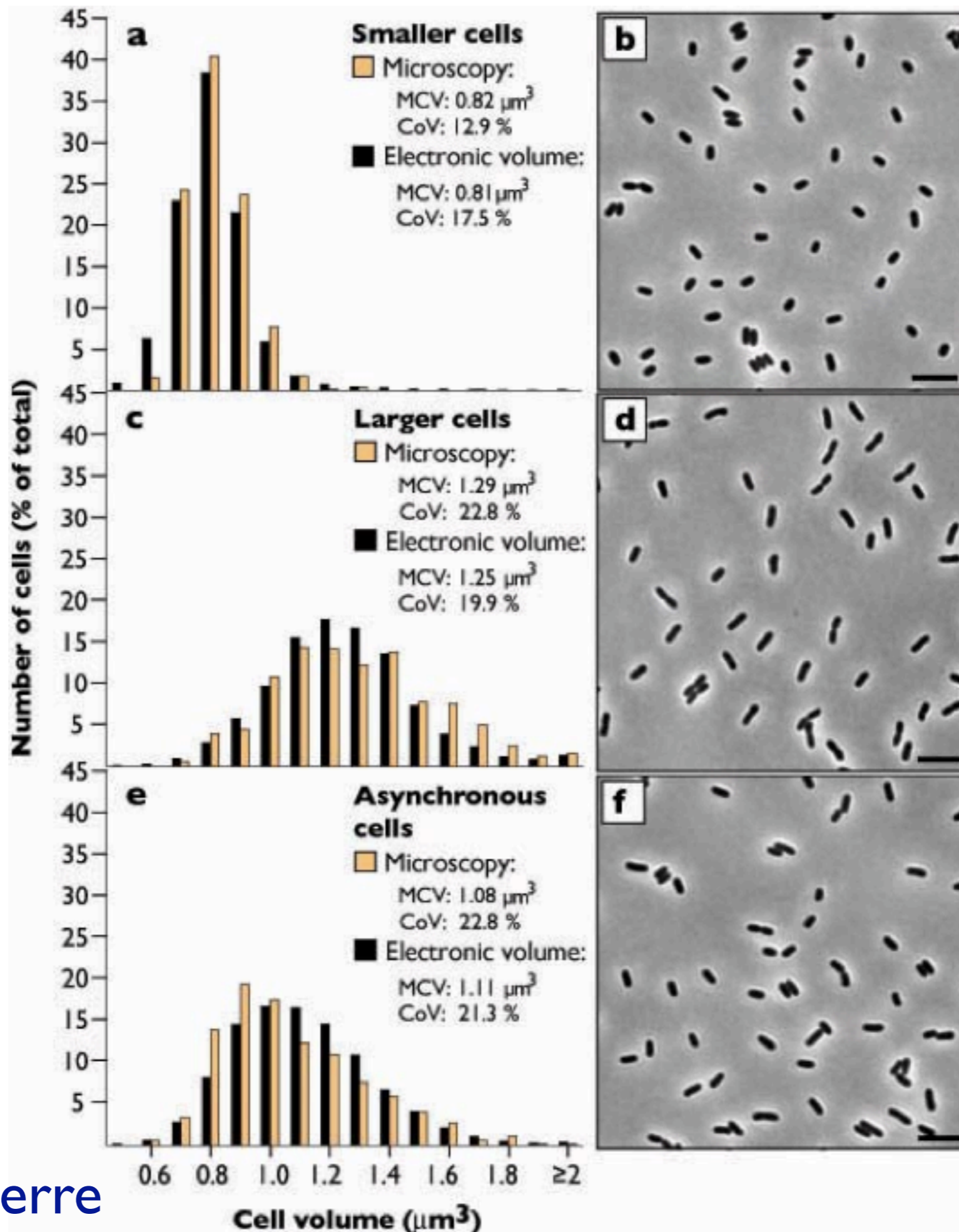



1

Infect with λ
cI857::KanR1 at
API=0.005

2

Incubate in TB at 30C for 30min

3

Remove free phages & plate

Lysogens

TB-Kan, 30C

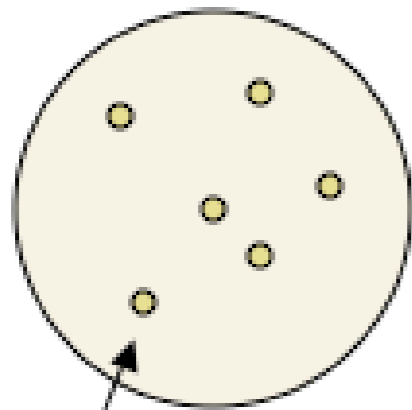

Colony

+

Lytic centers

TB plate, 30C

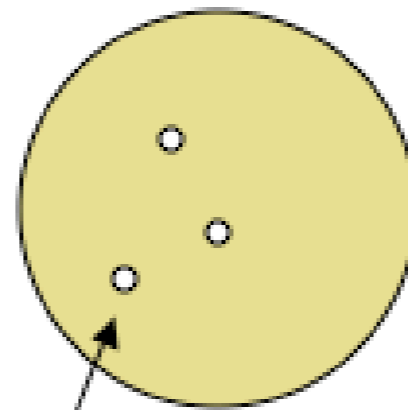

Plaque

?
=

Infectious centers

TB plate, 42C

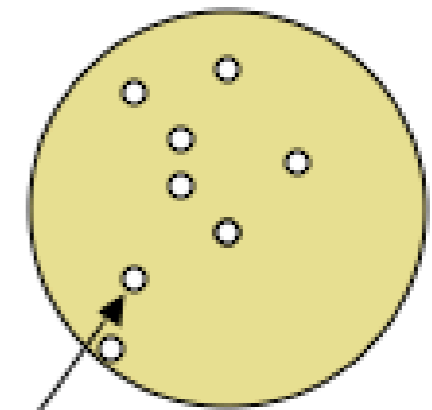

Plaque

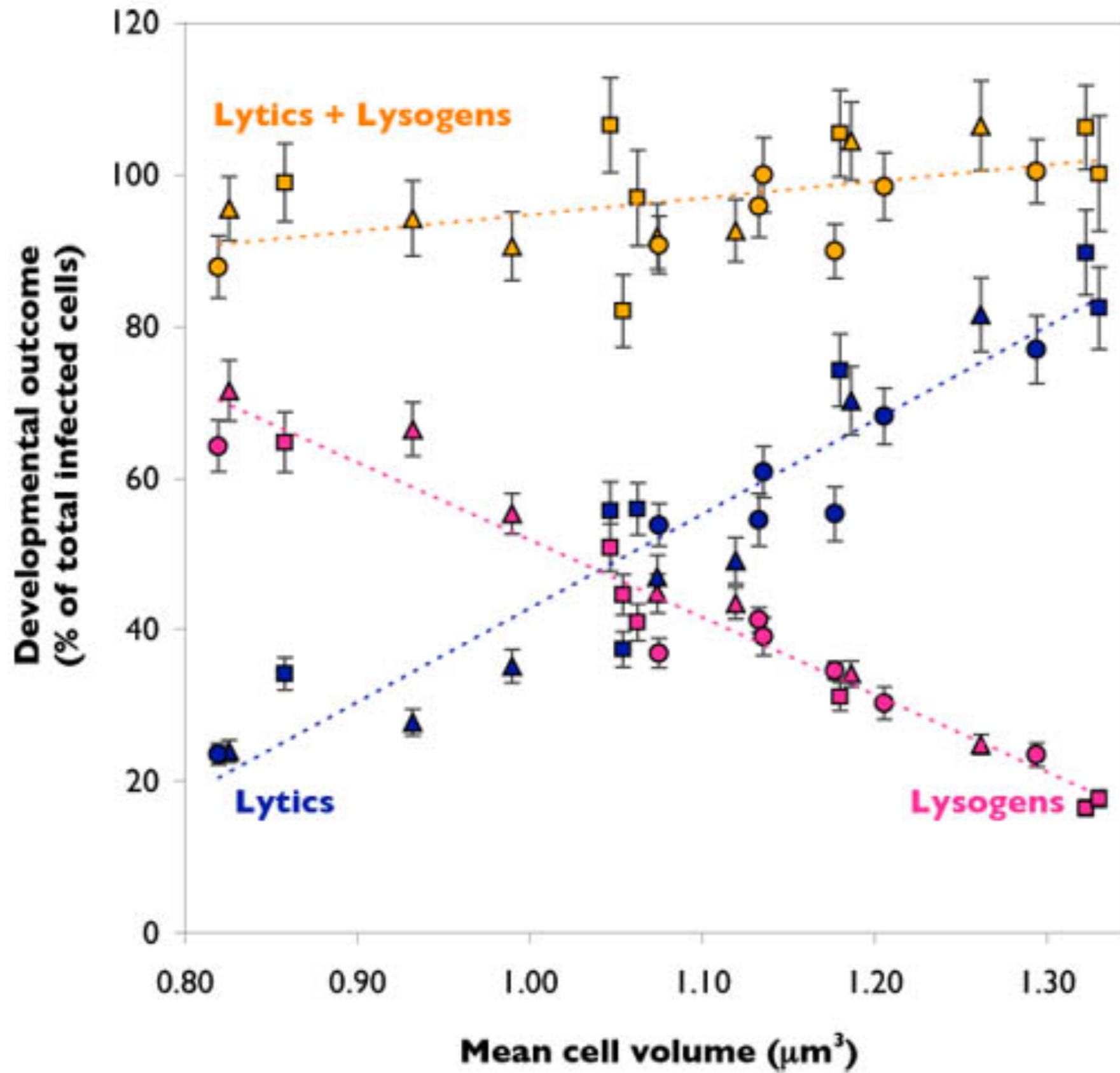

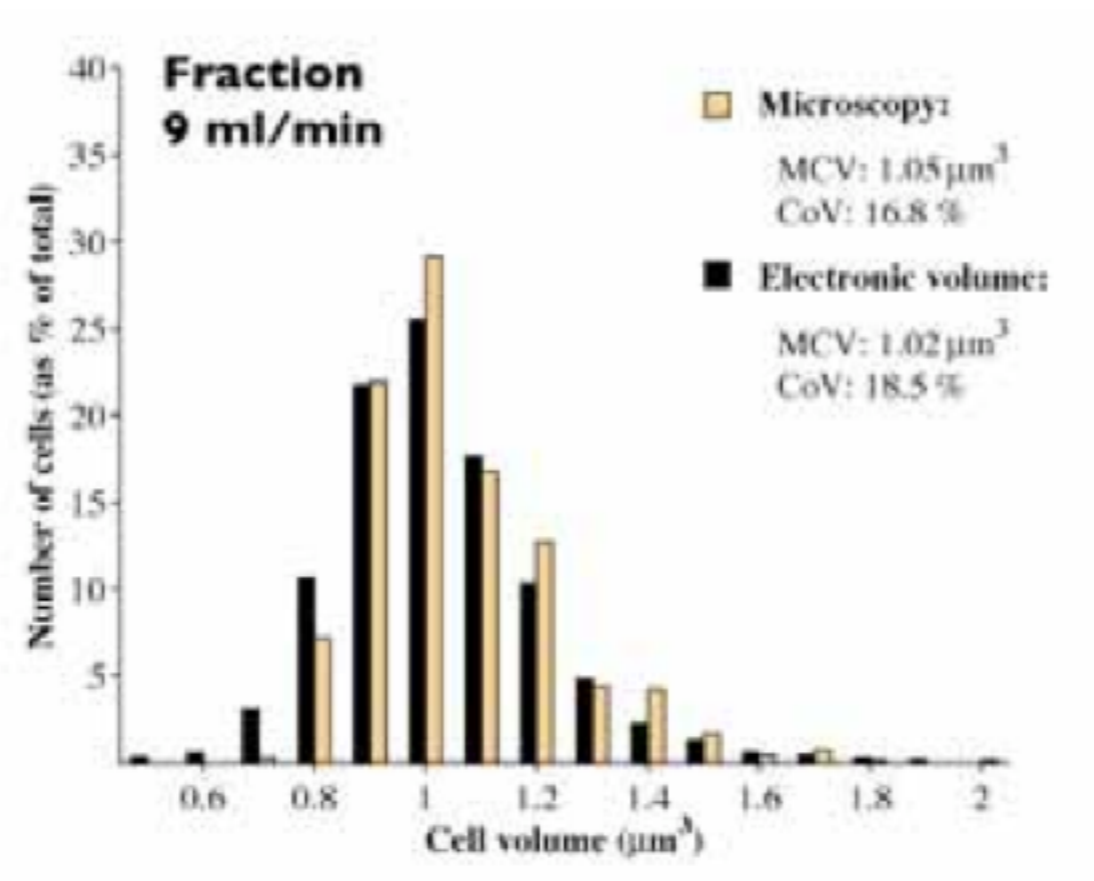

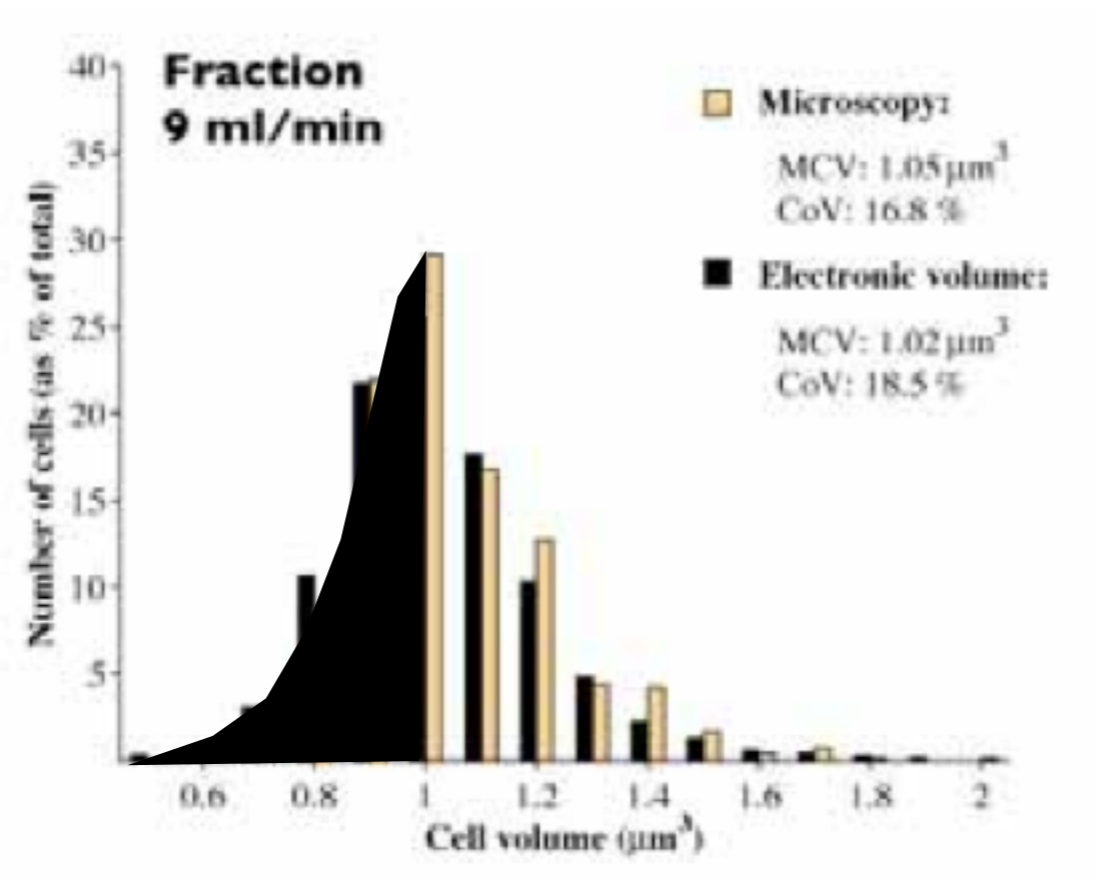

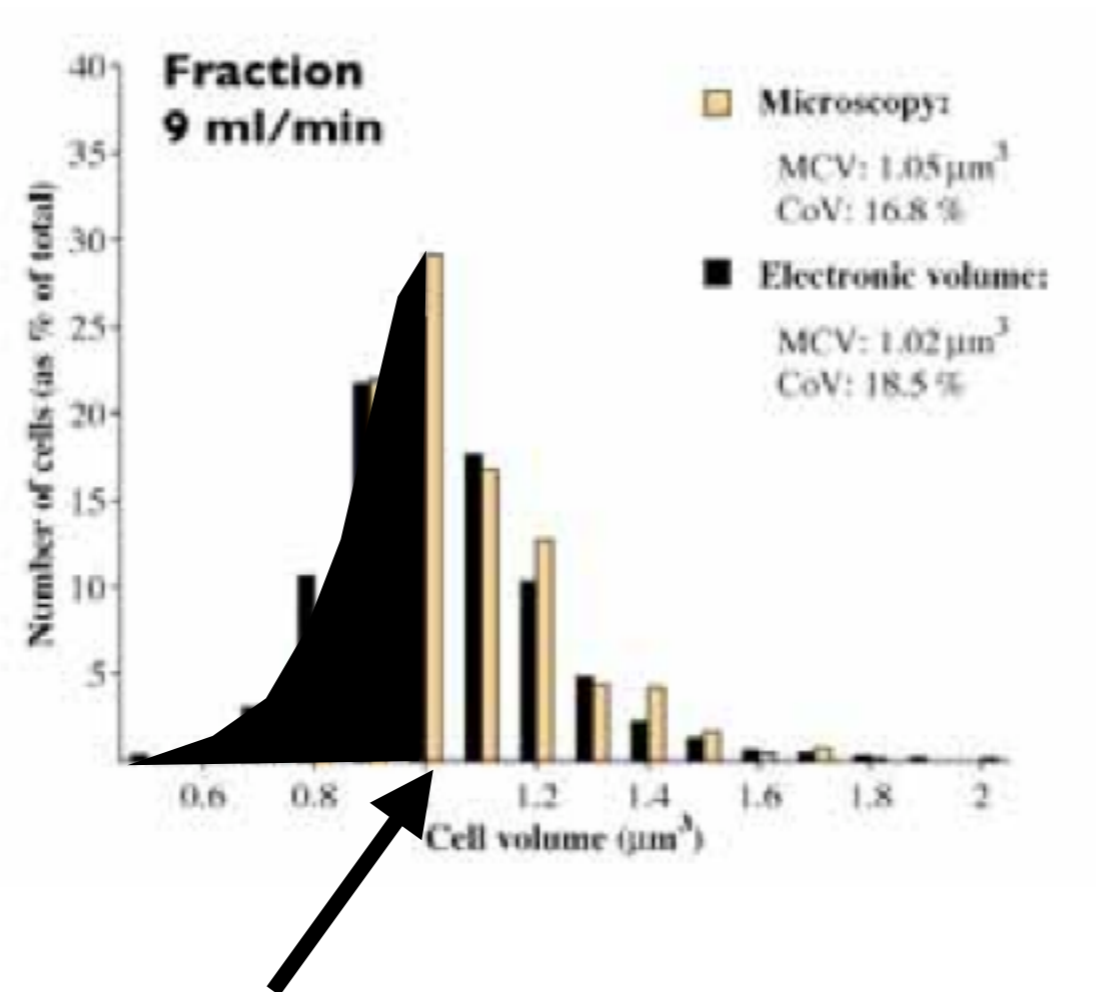

“Critical” volume for this fraction
(compute for all fractions)

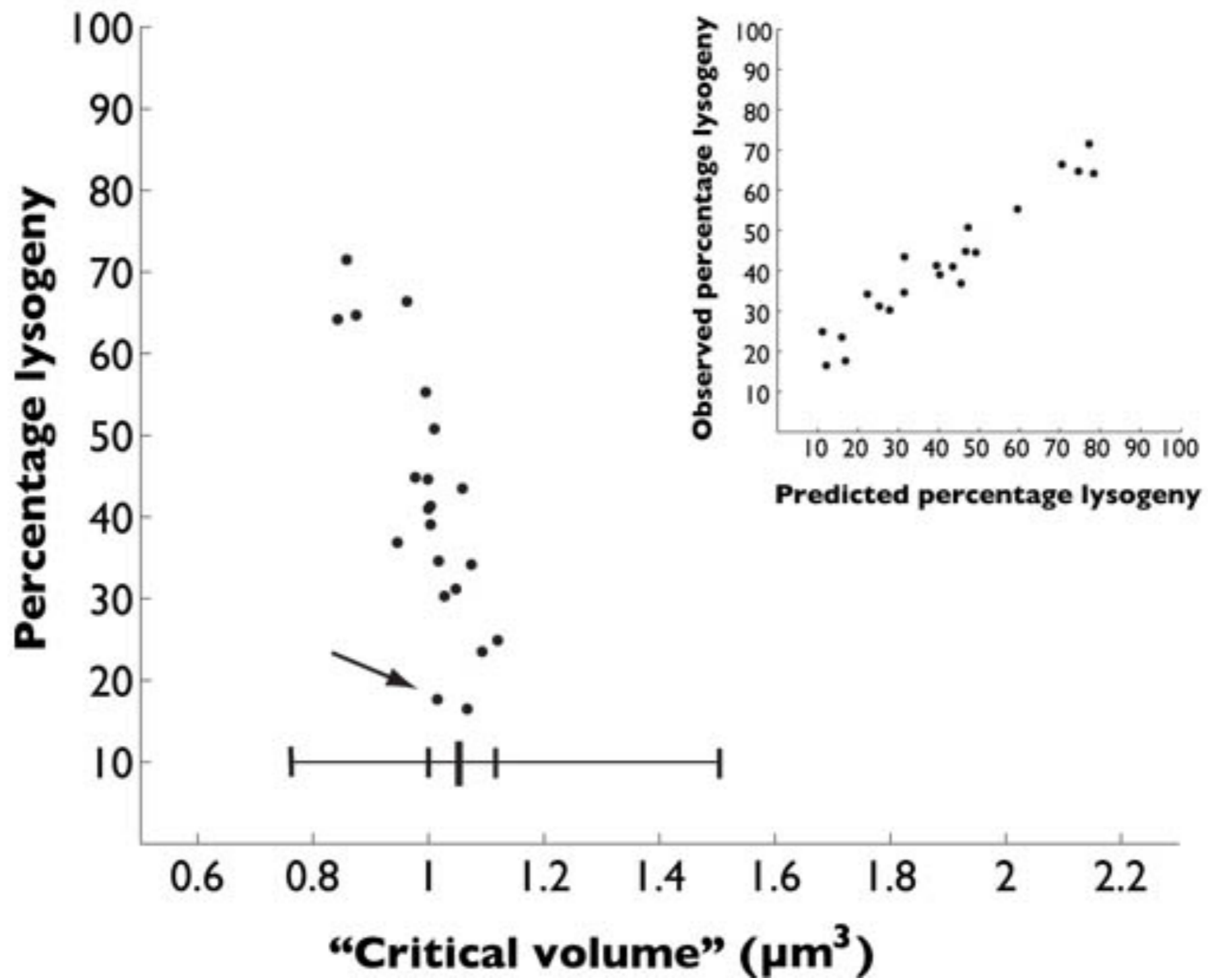

a Variation during lambda infection

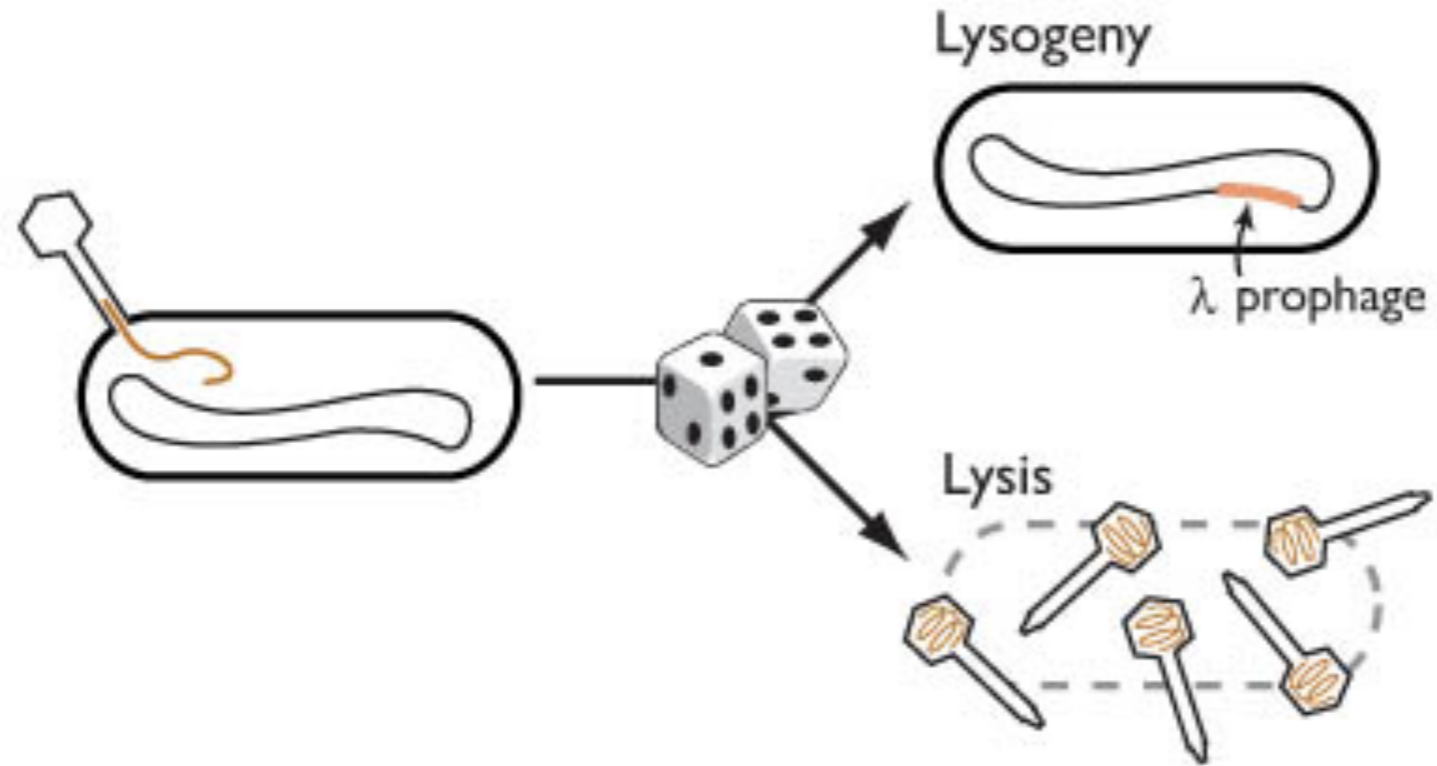

a Variation during lambda infection

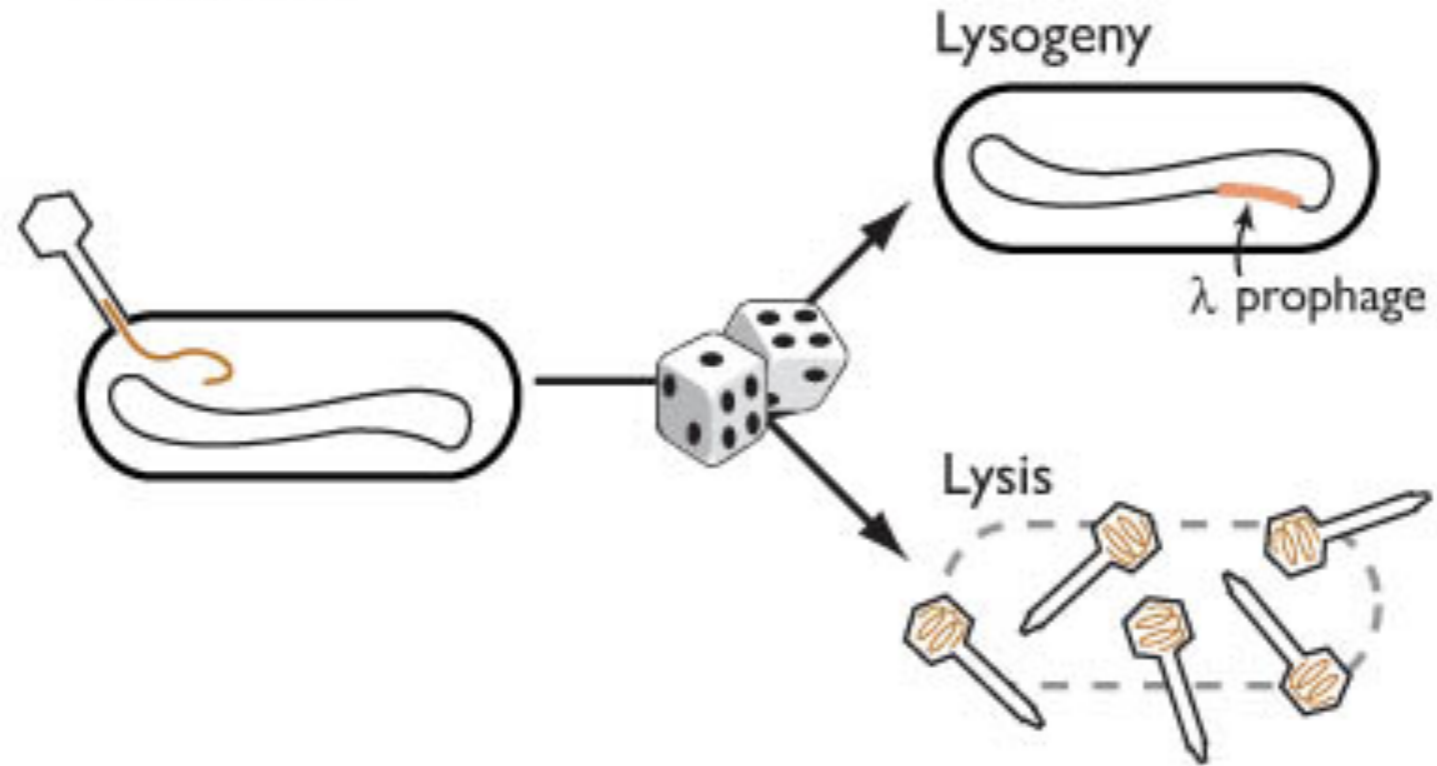

b Variation prior to lambda infection

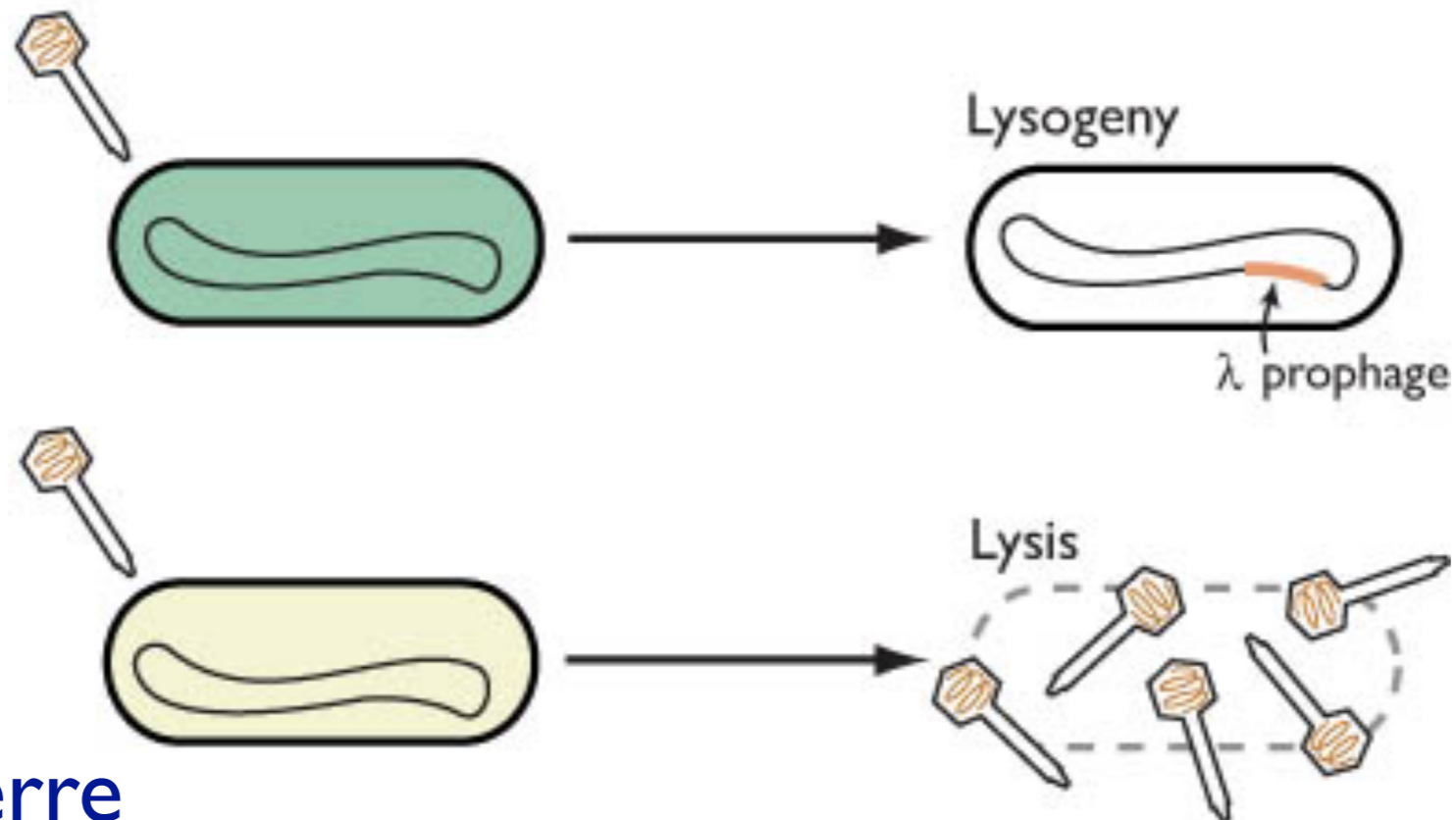

Show single cell movies!